

YZEM-3001  
May 16, 2024

# YZ300 and YZ320 INTERLOCK ANNUNCIATOR

For use with the Fireeye  
BurnerLogix™ Control



## DESCRIPTION

The FIREYE YZ300 (YZ320) Interlock Annunciator Module provides increased interlock supervision capability of the BurnerLogix System. The Interlock Annunciator Module connects to any YB110 (YB230) or ZB110 (ZB230) BurnerLogix chassis/amplifier by means of a cable, ( P/N ED580-2, ED580-4, ED580-8)

By wiring any of twenty interlock switches into the Interlock Annunciator Module, the BurnerLogix display automatically acts as a “first-out” annunciator for these interlocks. In addition, a fuel selection circuit providing full annunciation even if two fuels are fired simultaneously is standard. The YZ300 (YZ320) is shipped with default messages associated with each set of terminals. The user has the ability to modify these lockout messages in one of two ways:

1. Use the BLV512 or BLL510 display module to select a lockout alarm message for the individual terminals of the YZ300 (YZ320) from a library of available messages. Refer to Bulletins BL-1001 and/or BLZ-1001 for information regarding the operation of these controls.
2. Program a customized message (up to 40 characters in length) for the individual terminals of the YZ300 (YZ320) using a compatible PC with the Windows based YZ300P Programming software, available from Fireeye and the appropriate hardware. Note: The YZ300 (YZ320) Interlock Annunciator does not need to be connected to a BurnerLogix system to be custom programmed.

**Note:** Proper operation of the YZ300 (YZ320) requires a BurnerLogix YB110 (YB230) with an Engineering code of 3 or later or any ZB110 (ZB230) chassis/amplifier (Engineering codes are found after the date code, e.g., 0636-03).

The Interlock Annunciator Module does not interfere with the normal operation of the BurnerLogix System. It expands the message and diagnostic capability. The wiring bases for the YZ300 (YZ320) measure 4 in. wide by 7 in. tall, consuming a minimum amount of cabinet space. The wiring bases contain a 24-position terminal block, each position clearly numbered and each terminal utilizing a clamping mechanism to assure a good mechanical connection.

The YZ300 (YZ320) Interlock Annunciator module provides operational information and reduces troubleshooting time and expense. It expands the standard display messages of the BurnerLogix to identify the specific limit in the operating control circuit (L1-3) or running interlock circuit (3-P) which caused the burner shutdown or lockout. For a detailed description of the BurnerLogix System, see Bulletins BL-1001 or BLZ-1001.



## APPROVALS

### Underwriters Laboratories Inc.:

MCCZ File MP1537  
 Controls, Primary Safety - Listed  
 MCCZ2 File MP1537  
 Controls, Primary Safety - Component  
 MCCZ7 File MP1537  
 Controls, Primary Safety Certified for Canada  
 MCCZ8 File MP1537  
 Controls, Primary Safety Certified for Canada - Component

### Factory Mutual:

Approved







### Acceptable by:

Industrial Risk Insurers (I.R.I.)

### CE:

Gas Appliances  
 Gas Appliance Directive: 90/396/EEC  
 Low Voltage Directive: 73/23/EEC  
 EMC Directive: 89/336/EEC  
 GASTEC: 0063BT1754  
 (EN298, 2003; EN230, 2005)

Table 1: Agency Approvals

BurnerLogix Chassis/Flame Amp. Module	 APPROVED	 US LISTED	 US			
YZ300	X	X	X	X		
YZ320				X		

X = CERTIFICATION IN HAND

## SPECIFICATIONS

**Supply Voltage:** YZ300 - 120VAC (+ 10% - 15%), 50 / 60 Hz  
 YZ320 - 230VAC (+ 10% - 15%), 50 / 60 Hz

**Power Consumption:** 10 VA

**Protection Category:** NEMA1 (IP01)

**Ambient Temperature Levels:** -40F to +140F (-40C to +60C)

**Response Time:** 66 milliseconds Purge / 32 milliseconds Run

**Weight:** 1.1 lb. (0.5 kg)

**Humidity:** 85% R.H. non-condensing

**Cable Length:** 8 feet maximum



**WARNING: This equipment is a Class B digital apparatus which complies with the Radio Interference Regulations, CRC c.1374.**



**FIGURE 1. DIMENSIONS**

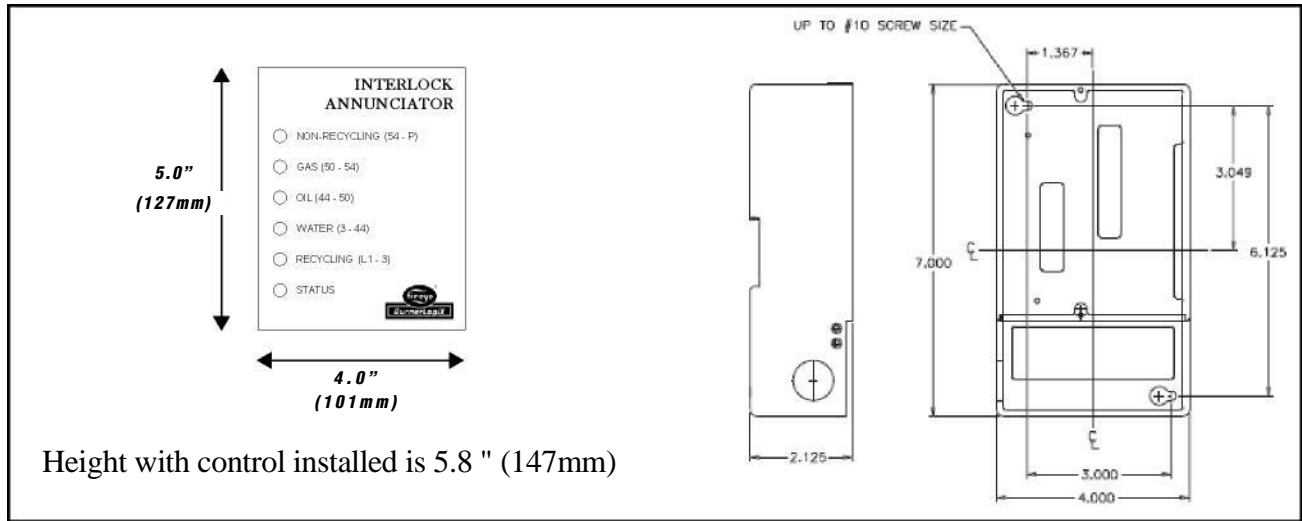

The location should be free from excessive vibration and within the ambient temperature rating.

## ORDERING INFORMATION

Part Number	Description
YZ300	Interlock Annunciator Module used with the YB110 or ZB110 BurnerLogix chassis/amplifier, 120 VAC, +10%, -15%, 50/60 Hz
YZ320	Interlock Annunciator Module used with the YB230 or ZB230 BurnerLogix chassis/amplifier, 230 VAC, +10%, -15%, 50/60 Hz
60-2872-1	Wiring base, terminal blocks, closed with knockouts
60-2874-1	Wiring base, terminal blocks, open end
ED580-2, -4, -8	YB110 or ZB110 to YZ300 interconnection cable in 2', 4' and 8' lengths
YZ300P	Windows based software for programming custom messages. Download from <a href="http://www.fireeye.com/Documents/YZ300P.zip">http://www.fireeye.com/Documents/YZ300P.zip</a>
EC485	RS232 to RS485 converter with power supply. Required to customize YZ300 messages
UC485	USB to RS485 converter with USB cable. Required to customize YZ300 messages
ED512-2, 4, -8	Cable with RJ12 connectors on each end. Required to customize YZ300 lockout alarm messages

## OPERATION

The YZ300 (YZ320) Interlock Annunciator Module is designed to expand the capability of the BurnerLogix System by allowing the operator to individually track the operation of four (4) recycling interlocks and sixteen (16) running interlocks (non-recycling). The recycling interlocks are wired between the L1-3 terminals on the BurnerLogix wiring base and the non-recycling interlocks are in the 3-P circuit.

Referring to the wiring diagram, Figure 2 on page 8, the operating control and auxiliary limits 1, 2 and 3 will act as an operating control to recycle the burner. Whenever any of the auxiliary limits are open and the other limits are closed, the message on the display of the BurnerLogix control will indicate:

### STANDBY

#### L1-3 AUX #1(or #2, or #3) OPEN (or the appropriate modified message)

Similarly, the interlocks in the 3-P circuit will change the standard running interlock message on the display from: LOCKOUT 3-P INTLK OPEN to one which will individually identify the sixteen (16) interlocks now being monitored by the YZ300 (YZ320), such as, LOCKOUT LOW OIL TEMPERATURE (or the appropriate modified message). The interlock switch chosen will be selected on a



“first out” basis. The first switch which opens in the string to cause the condition will be displayed. The 3-P circuit is immediately monitored after a burner start-up.

When a “lockout” condition is manually reset, the display on the BurnerLogix and the Interlock Annunciator Module is ready to begin a new burner sequence. Note the section *Lockouts* in the Bulletin BL-1001 or BLZ-1001.

Whenever more than one interlock switch in the L1-3 circuit is open on a start-up, the open interlock switch wired in the sequence closest to the L1 terminal will be displayed. Whenever more than one interlock switch in the 3-P circuit is open on a startup, the open interlock switch closest to terminal 3 will be displayed.



**CAUTION: The YZ300 (YZ320) messages are stored within the Interlock Annunciator Module. The YZ300 (YZ320) messages shown in Table 2 on page 5, and on the wiring diagram, Figure 2 on page 8, represent the default messages that are shipped with each Interlock Annunciator module. Unless these default messages are modified via the BLL510 or BLV512 display module or customized via a PC (Refer to CUSTOMIZING YZ300 (YZ320) MESSAGES in this bulletin), the YZ300 (YZ320) must be wired EXACTLY AS SHOWN, in the sequence as shown in the wiring diagram, Figure 2 on page 8, to ensure proper operation.**

The YZ300 (YZ320) must be connected to the BurnerLogix control to provide access to the additional lockout messages associated with the YZ300 (YZ320) Expansion Module.

In operation, the 3 to P and L1 to 3 circuits are checked each half cycle by separate photo optical couplers in the BurnerLogix system to determine if any interlock is open. Upon detecting an open interlock, the BurnerLogix control initiates a LOCKOUT or HOLD message, then requests information from the YZ300 (YZ320) to determine which interlock corresponding to terminals 43 through 59 and L1 through 42 (on YZ300 [YZ320]) to determine which of the interlocks closest to terminal 3 (3-P circuit) or closest to terminal L1 (L1-3 circuit) is open. The BurnerLogix then selects the corresponding message from the stored message list and displays it. The YZ300 (YZ320) messages then become a part of the historical data which is stored in the BurnerLogix system memory.

Any interlock in the 3-P or in the L1-3 circuit that opens for at least 33-50 ms while the burner is ON, or for at least 66 ms while the unit is in PURGE will cause the YZ300 (YZ320) and the BurnerLogix control to respond with the proper message. Interlock contacts that temporarily open for shorter time periods will be ignored. Refer to Figure 2 on page 8 for DEFAULT MESSAGES.

---

## SPECIAL NOTES ON OPERATION

After the start of PTFI, if any recycle (L1-3) or running interlock (3-P) limit opens, the BurnerLogix control will display a POST PURGE message for 15 (or selected post purge time) seconds before displaying the appropriate message. The appropriate LED located on the face of the YZ300 (YZ320) will flash to indicate in what section of the circuit the interlock is open.

On recycle type programmers (e.g. YP200 or YP300 set for recycle operation), if a running interlock (3-P) limit opens, the control will shutdown, perform a post purge and then try to restart. The control will hold for ten (10) minutes during purge waiting for the limit to close. If a second running interlock opens during this "hold" period, the message may change to reflect the new interlock.

If the operating control limit or auxiliary limit #1, #2 or #3 opens during a firing cycle, the control will initiate a 15 second post purge and then go to standby and display the message pertaining to the interlock that opened. The BurnerLogix will wait for all interlocks in the L1-3 circuit to close to begin a new cycle.

If multiple interlocks in the 3-P circuit are opened during the start of a burner cycle, the first interlock in the following sequence will be displayed.



## LED INDICATORS

The YZ300 (YZ320) contains 6 LED's that provide information that can be useful in determining the current state of the interlocks wired between terminals L1 and P of the BurnerLogix control.

<p><b>STATUS</b> – indicates red when the ED580 connection to the BurnerLogix is interrupted, green when connection is established.</p> <p><b>RECYCLING</b> illuminates steady when all interlocks between terminal L1 and 3 are closed and powered. Blinks if any interlock is open.</p> <p><b>WATER</b> – illuminates steady when Low Water and High Water are closed and powered, blinks if any is open.</p> <p><b>OIL</b> illuminates steady if all oil interlocks between terminals 44 and 55 are closed and powered and oil is an active fuel, blinks if any oil interlock is open.</p> <p><b>GAS</b> illuminates steady if all gas interlocks between terminals 50 and 54 are closed and powered and gas is an active fuel, blinks if any gas interlock is open.</p> <p><b>NON-RECYCLING</b> - illuminates steady when all interlocks between terminals 54 and P are closed and powered, blinks if any interlock is open.</p>	<ul style="list-style-type: none"> <li>○ NON-RECYCLING (54 - P)</li> <li>○ GAS (50 - 54)</li> <li>○ OIL (44 - 50)</li> <li>○ WATER (3 - 44)</li> <li>○ RECYCLING (L1 - 3)</li> <li>○ STATUS</li> </ul>
--	--

**Table 2: YZ300 (YZ320) DEFAULT MESSAGES**

OIL MODE		GAS MODE	
Terminal	Message	Terminal	Message
<b>Recycling Limits</b>			
L1-40	Op Control Open	L1-40	Op Control Open
40-41	L1-3 Aux#1 Open	40-41	L1-3 Aux#1 Open
41-42	L1-3 Aux#2 Open	41-42	L1-3 Aux#2 Open
42-3	L1-3 Aux#3 Open	42-3	L1-3 Aux#3 Open
<b>Non-Recycling Limits</b>			
3-43	High Water	3-43	High Water
43-44	Low Water	43-44	Low Water
<b>For OIL select, connect terminal 49 to 53</b>		<b>For GAS select, connect terminal 45 to 49</b>	
45-46	High Oil Temperature	50-51	Low Gas Pressure
46-47	Low Oil Temperature	51-52	High Gas Pressure
47-48	Low Oil Pressure	52-53	Aux Gas
48-49	Low Atomizing Media		
54-55	High Pressure	54-55	High Pressure
55-56	High Temperature	55-56	High Temperature
56-57	Aux #1 Open	56-57	Aux #1 Open
57-58	Aux #5 Open	57-58	Aux #5 Open
58-59	Aux #6 Open	58-59	Aux #6 Open
59-60	Aux #7 Open	59-60	Aux #7 Open
60-P	Air Flow Open	60-P	Air Flow Open



## INSTALLATION AND WIRING

### Wiring Base

Install the wiring base where the relative humidity never reaches the saturation point. The YZ300 (YZ320) Interlock Annunciation system is designed to operate in a maximum 90% relative humidity continuous, non-condensing environment. Do not install the YZ300 (YZ320) where it can be subjected to vibration in excess of 0.5G continuous maximum vibration. The BurnerLogix system is not a weather tight enclosure. The standard vertical position is recommended. Allow at least one inch clearance around the control for service and installation.

1. Wiring must comply with all applicable codes, ordinances, and regulations.
2. **Wiring must comply with NEC Class 1 (Line Voltage) wiring.**
3. Limits and interlocks must be rated to simultaneously carry and break current to the ignition transformer, pilot valve and main fuel valve(s).
4. Maximum wire lengths:
  - a. The maximum lead wire length is 200 ft. (61 meters) to terminal inputs (Operating limits, interlocks, valves, etc.).
  - b. Modbus communications: The maximum cable length of wire is 3300 feet (1000 meters) for RS-485.

A good ground system should be provided to minimize the effects of AC quality problems. A properly designed ground system meeting all the safety requirements will ensure that any AC voltage quality problems, such as spikes, surges and impulses have a low impedance path to ground. A low impedance path to ground is required to ensure that large currents involved with any surge voltages will follow the desired path in preference to alternative paths, where extensive damage may occur to equipment.



**WARNING: Controls require safety limits utilizing isolated mechanical contacts. Electronic limit switches may cause erratic operation and should be avoided.**

Wiring bases 60-2872-1 and 60-2874-1 each contain a 24 position terminal block. Each terminal can accept either 2 type 16 AWG wires or a single type 14 AWG wire. Each terminal is a clamp type terminal that provides sufficient pressure against the wire.

**For any interlock of the YZ300 (YZ320) that is not used, a jumper must be placed between those two terminals. For example, if AUX LIMIT #7 is not used, a jumper must be placed from terminal 59 to terminal 60.**

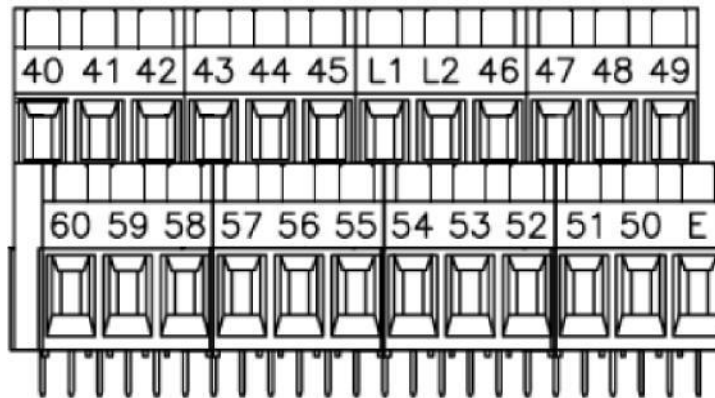

**The fuel select switch connects to terminals 45, 49 and 53.**

**Terminals 44 & 45, 49 & 50 and 53 & 54 are internally connected.**

**Important:** If a particular interlock is not used, a jumper must be installed on the terminals of the Interlock Annunciator Module wiring base which corresponds to that unused interlock. For example: if the system has no high temperature switch and no need for auxiliary limits 5 and 6, a jumper should be placed between terminals 55 and 56, 57 and 58, 58 and 59.

**Important:** When a single fuel burner is used, a fuel selector switch is not necessary. However, the fuel selection terminals for the unused fuel type must be jumped out.

**For gas only:** connect terminal 45 to 49

**For oil only:** connect terminal 49 to 53

When the fuel selector switch is in the GAS position, the 4 oil interlocks are ignored by The Burner-Logix Control. When the switch is in the OIL position, the 3 gas interlocks are ignored.

**CAUTION:** All YZ300 (YZ320) wiring should not interfere with the safety function or operation of any of the interlocks. Check each interlock for proper operation after wiring

### INTERCONNECTING YZ300 (YZ320) TO BURNERLOGIX

Remove the RJ485 plug from the EXP port located on the underside of the BurnerLogix control. Plug end of ED580 cable with ferrite core into EXP port of the BurnerLogix control. Plug the other end of the ED580 cable into the EXP port located on the underside of the YZ300 (YZ320) Interlock Annunciator.

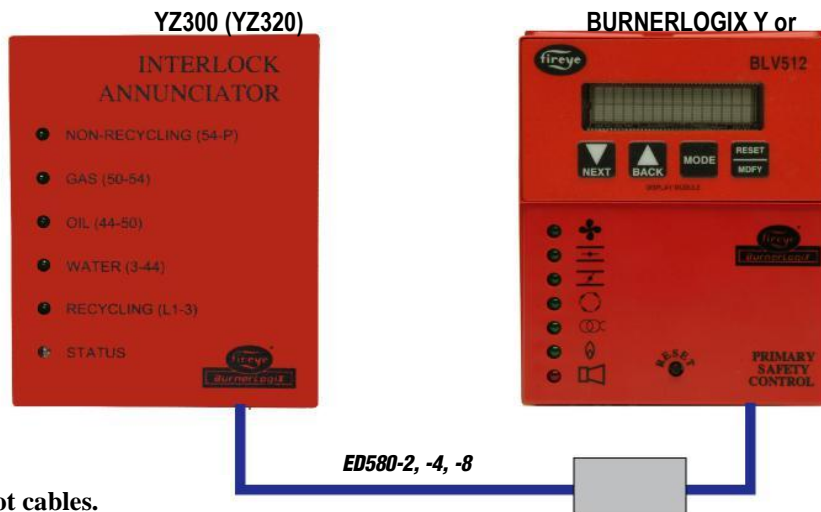

Choose 4- or 8-foot cables.  
Plug into EXP port of each control.

**CAUTION:** While power is on and the interconnection between the YZ300 (YZ320) and BurnerLogix has been established, if either the ED580 cable is unplugged or the YZ300 (YZ320) ceases to communicate with the BurnerLogix control for 3 consecutive minutes, the BurnerLogix (Y or Z) will move to lockout with a CHECK EXP MODULE message. Resetting the control with the ED580 cable unplugged will resume normal operation.

FIGURE 2. WIRING DIAGRAM FOR DEFAULT MESSAGES

Note: Terminals 44 & 45, 49 & 50 and 53 & 54 are internally connected.

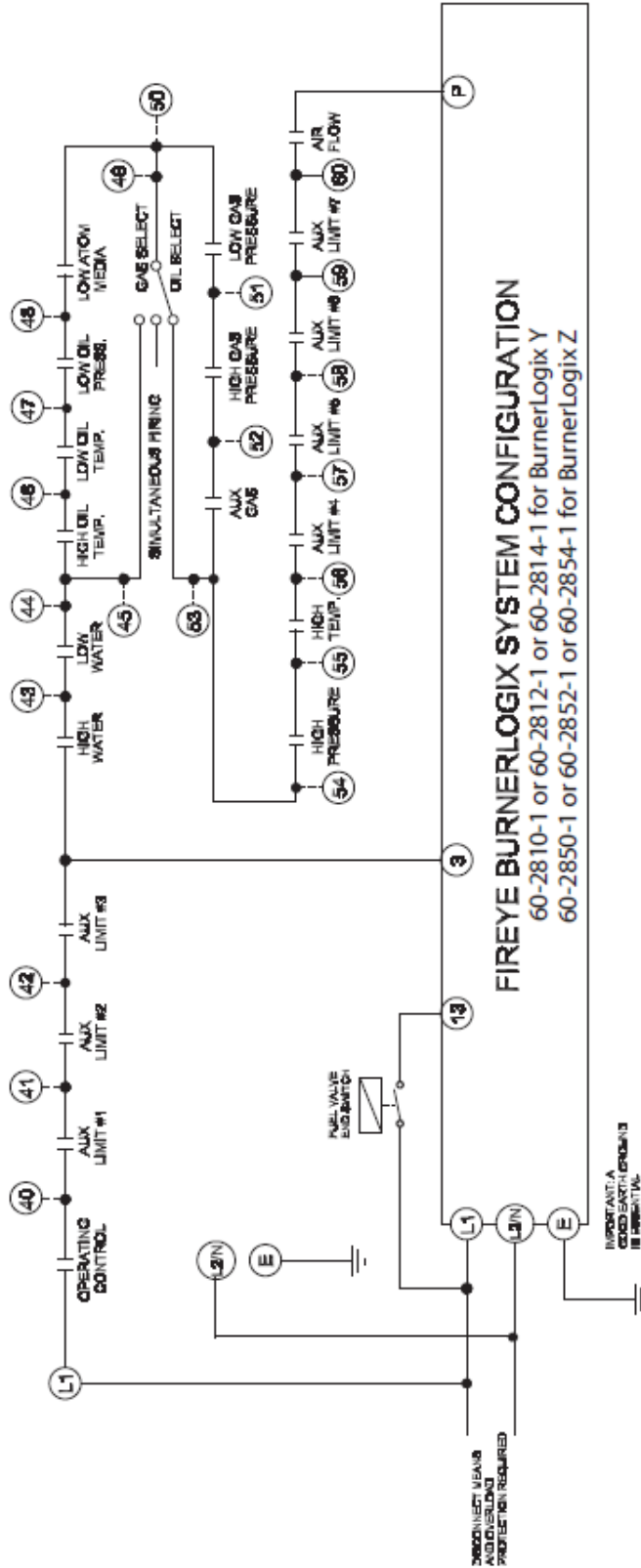

Note: All existing wiring on terminals not shown will be undisturbed when the YZ300 (YZ320) is installed.

**Remove all power from the BurnerLogix control and the YZ300 (YZ320) before wiring.**



For any interlock of the YZ300 (YZ320) that is not used, a jumper must be placed between those two terminals. For example, if AUX LIMIT #7 is not used, a jumper must be placed from terminal 59 to terminal 60.





---

## YZ300 (YZ320) MESSAGE SELECT

The sub-menu "YZEM MSG SELECT" will allow the user to modify the recycle and non-recycle messages associated with the operation of the YZ300 (YZ320) Interlock Annunciator Module and BurnerLogix. The use of the default messages requires the system to be wired as shown in the wiring diagram. For example, the low water cutoff had to be wired between terminals 43 and 44 of the YZ300 (YZ320). The YZEM MSG SELECT option now allows the user to select from a library of messages and program each interlock terminal as required. The messages associated with the YZ300 (YZ320) are divided into four (4) groups: **Recycle, Non-recycle, Gas Select, and Oil Select.**

The **Recycle** group pertains to the limits that are connected between terminals L1 and 3 of the BurnerLogix. These are terminals L1-40, 40-41, 41-42, and 42-3.

The **Non-Recycle** group pertains to the limits that are connected between terminals 3 and P of the BurnerLogix. These are terminals 3-43, 43-44, 54-55, 55-56, 56-57, 57-58, 58-59, 59-60 and 60-P.

The **Gas Select** group pertains to the terminals associated with the gas interlocks of the YZ300 (YZ320). These are terminals 50-51, 51-52, and 52-53.

The **Oil Select** group pertains to the terminals associated with the oil interlocks of the YZ300 (YZ320). These are terminals 45-46, 46-47, 47-48, and 48-49.

The lockout messages associated with the above terminals can be modified via either the BLL510 or BLV512 displays.

The selection of available messages are dependent on each group. For example, the message "Low Oil Pressure" is a selection only for the Oil Select group. The default message for a particular interlock is the standard message for those terminals. For example, the default message for terminals 4041 is "L1-3 AUX #1 OPEN."

### TO MODIFY THE YZ300 (YZ320) MESSAGES

All four keys: NEXT, BACK, MODE, and RESET/MDFY are used to enter or exit the sub-menu associated with the YZ300 (YZ320) messages. The NEXT or BACK keys are used to scroll through the various terminals and selectable messages. The RESET/MDFY key is used to modify and save a new message for each of the YZ300 (YZ320) Interlock Annunciator terminals.

**Library messages cannot override custom programmed messages.**

To modify the YZ300 (YZ320) messages:

Press the NEXT or BACK key until the BLL510 or BLV512 displays:

YZEM MSG SELECT>

Press the MODE key to enter the sub-menu and the screen displays:

**TRM #40-41**

**MDFY**

**L1-3 AUX#1 OPEN**

or previously selected

message. Press the NEXT key and the screen displays:

**TRM #41-42**

**MDFY**

**L1-3 AUX#2 OPEN**

or previously selected message.

To change the message, press and hold the RESET/MDFY key for one (1) second. When the RESET/MDFY key is released, the screen displays:

**TRM #41-42**

**SAVE**

**L1-3 AUX#2 OPEN**

Press the NEXT or BACK key to display the available messages for the particular group being modified. See attached List of available messages for each group.



When the messages displayed is appropriate for the terminals, press and hold the RESET/MDFY key for one (1) second. When the RESET/MDFY key is released, the screen displays:

TRM #41-42

MDFY

LOW WATER

Press the MODE key to exit the YZ300 (YZ320) Message Sub-menu.

---

## AVAILABLE YZ300 (YZ320) MESSAGES

The following messages are available for each of the four YZ300 (YZ320) terminal groups:

**GROUP 1 — RECYCLE**

OP CNTL OPEN  
DAMPER POSITION END SWITCH OPEN  
COMBUSTION AIR END SWITCH OPEN  
LOW WATER  
HIGH GAS PRESSURE  
LOW GAS PRESSURE

HIGH WATER  
BLOWER MOTOR INTLK  
HIGH STACK TEMPERATURE  
CONTROL PANEL SWITCH OPEN

**GROUP 2 — OIL SELECT**

LOW OIL PRESSURE  
HIGH OIL PRESSURE  
LOW OIL TEMPERATURE

HIGH OIL TEMPERATURE  
LOW ATOMIZING MEDIA

**GROUP 3 — GAS SELECT**

HIGH GAS PRESSURE  
LOW GAS PRESSURE  
AUX GAS

**GROUP 4 — NON-RECYCLE**

SAFETY INLK OPEN  
HIGH WATER  
LOW WATER  
HIGH PRESSURE  
BLOWER MOTOR INTLK  
ID FAN INTLK  
FD FAN INTLK

HIGH TEMPERATURE  
AIR FLOW OPEN  
OIL GUN END SWITCH OPEN  
HIGH STACK TEMPERATURE

---

## USER PROGRAMMED YZ300 (YZ320) MESSAGES

In addition to selecting the hold or lockout alarm messages for the YZ300 (YZ320) Interlock Annunciator Module from the menu selection via the BLL510 or BLV512 display, the user can also program any message (up to 40 characters in length) for the individual terminals of the YZ300 (YZ320). Fireeye provides a Windows based program YZ300P to facilitate this process.

**The YZ300 (YZ320) Interlock Annunciator need NOT be connected to the BurnerLogix in order to program customized messages.**

The following equipment is required:

- A computer running Windows.
  - A copy of YZ300P software provided by Fireeye.
  - An RS232 to RS485 converter, serial port required (P/N EC485 or IC485 – includes necessary power supply) or USB to RS485 converter (P/N UC485).
  - An ED512-2, -4, or -8 cable Setup
1. Connect the EC485 (or equivalent) to the serial COM or USB (or equivalent) port of the PC.
  2. Connect the RJ12 female connector (provided with the EC485, IC485 or UC485 (preferred)) to terminals TD(A), TD(B), RD(A) and RD(B) on the UC485. The pins on the RJ12 connector should line up with the terminals on the converter.

UC485 or equivalent  
see UC-4851 for setup &  
configuration.

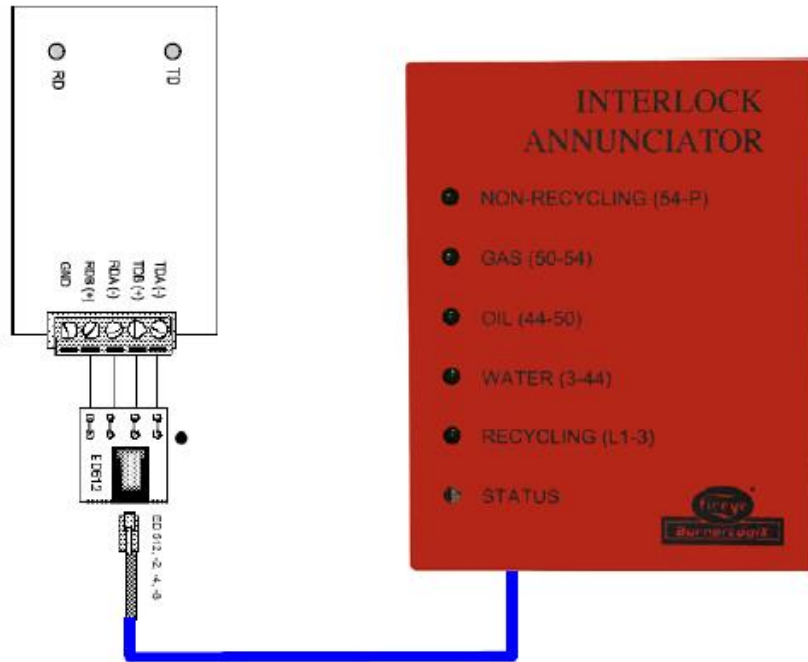

**ED512, connect to  
either COMMS port**

3. Plug one end of the ED512-2, -4 or -8 cable into the RJ12 jack on the UC485 and the other end into either of the RJ12 jacks located on the underside of the YZ300 (YZ320) Interlock Annunciator.
4. The YZ300 (YZ320) must be powered and if not connected to the BurnerLogix, the default address is set to 1 and the baud rate is 9600,N,8,1.

**If the COMMS of the BurnerLogix and YZ300 (YZ320) are connected together, the YZ300 (YZ320) assumes the address and baud rate of the BurnerLogix control. Check PROGRAM SETUP sub-menu for the current settings.**

## RUNNING THE YZ300P SOFTWARE

1. Run the YZ300P software on the PC. A splash screen, a list of available COM ports will be displayed. Use the TAB and arrow keys or mouse to select the proper port.



2. A list of available communication baud rates will appear. Use the TAB and arrow keys or mouse to make the proper selection.



3. A list of available Modbus ID from 0 -247 will appear. Use the TAB and arrow keys or mouse to make 1 the proper selection.

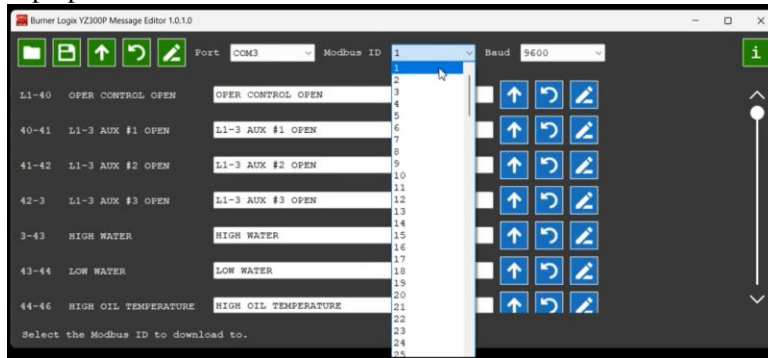

## USING THE YZ300P SOFTWARE

Initially, the YZ300P displays the default messages of the YZ300 (YZ320) Interlock Annunciator. The Command Center allows the user to Read, Write and Erase all stored messages, Open and Save the message file and select the communication address. Pressing the Quit bar will terminate the program.

- **Read** - the YZ300P will read all messages currently stored in the YZ300 (YZ320) and display the custom message in the appropriate location. If no message is stored, the default message will be displayed. (Library selected messages will not be displayed on the YZ300P).
- **Write** - the YZ300P will upload or write all messages to the YZ300 (YZ320). If the message displayed on the YZ300P screen is a default message, then no writing of that message location will take place.
- **Erase** - the YZ300P will send an erase message command to each message location in the YZ300 (YZ320) and restore that message location to the factory default condition, no message stored.

During the Read, Write and Erase operations, the progress bar located on the YZ300P screen will move left to right indicating the status of the selected operation.

- **Save** - the YZ300P allows the current message file to be stored for later recall and re-programming of other YZ300 (YZ320) Interlock Annunciators. Clicking Save will open a dialog box allowing the user to store the current message file using any descriptive name. The user must select or create the appropriate folder location to store the file. Typically, the YZ300P want saved files to have the '.sav' extension. If no file extension is specified, the YZ300P will append each saved file with the '.sav' extension automatically. Click on Save after the file name is specified.



## Save File Dialog Box

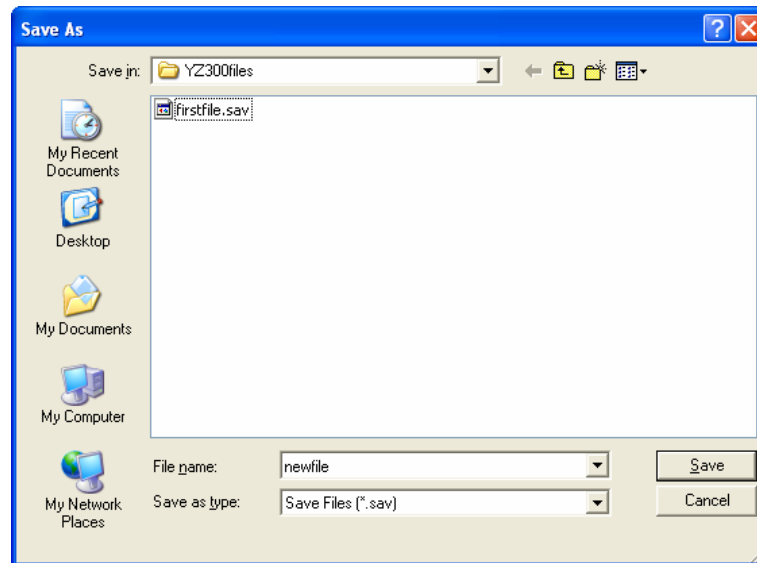

- **Open** - The YZ300P allows the user to open an existing file that can be used to upload to a new YZ300 (YZ320). Clicking Open will open a dialog box showing all files with the '.sav' extension in the folder displayed. Click on the desired file and then Open. The file will be read into the program and the screen will be populated with the messages from the file. Clicking on Write will upload these messages to the connected YZ300 (YZ320). This is especially helpful when customizing messages in multiple devices or replacing a unit currently installed.

## CUSTOMIZING OR ERASING A MESSAGE

To customize or erase a message, on the YZ300P screen, click on the particular message and the following dialog box will appear.

## Write or Erase Message Dialog Box

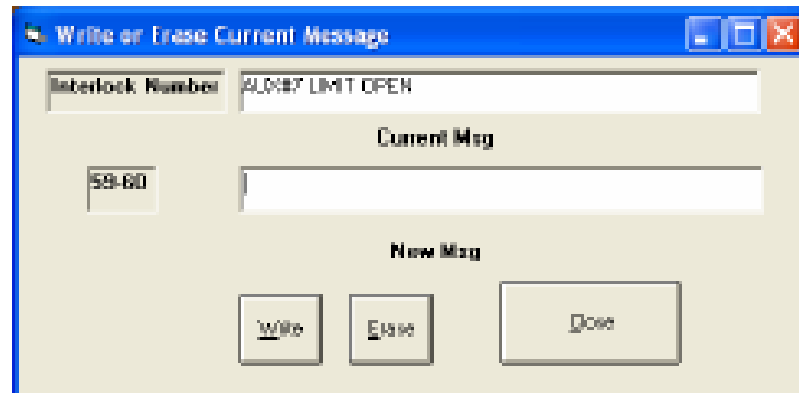

The current message pertaining to that interlock location is displayed and a text box is available to enter in the new message. The new message cannot exceed 40 characters in length and also the new message is not case sensitive. When complete, click on the Write button to send the message to the YZ300 (YZ320). A confirmation will appear indicating if the message transfer was successful. This same dialog box can be used to also erase the message in the current location and return the message to factory default or no message stored. When complete, click on Close to return to the YZ300P screen. The new message for the selected interlock will appear in the selected location. The file can then be saved for later use.



---

## NOTICE

When Fireeye products are combined with equipment manufactured by others and/or integrated into systems designed or manufactured by others, the Fireeye warranty, as stated in its General Terms & Conditions of Sale, pertains only to the Fireeye products and not to any other equipment or to the combined system or its overall performance.

---

## WARRANTIES, EXCLUSIVE REMEDIES, AND LIMITATION OF DAMAGES

Fireeye guarantees for one year from the date of installation or 18 months from the date of manufacture, whichever occurs first, to replace, or at its option, to repair any product or part thereof which Fireeye, in its sole discretion, deems to be defective in material or workmanship or which otherwise fails to conform to the description of the product on the face of its sales order. Fireeye's obligations pursuant to this warranty do not extend to any products or parts thereof which Fireeye determines to have been installed, operated, maintained, repaired, or altered improperly or otherwise than in conformity to Fireeye's applicable instructions, or which have been subject to misuse, accident, or neglect.

**THE FOREGOING IS IN LIEU OF ALL OTHER WARRANTIES, BOTH EXPRESS AND IMPLIED, INCLUDING THE WARRANTIES OF MERCHANTABILITY AND FITNESS FOR A PARTICULAR PURPOSE. EXCEPT AS SPECIFICALLY STATED IN THESE TERMS AND CONDITIONS OF SALE, REMEDIES WITH RESPECT TO ANY PRODUCT OR PART MANUFACTURED OR SOLD BY FIREYE, OR WITH RESPECT TO ANY BREACH OF OR DEFAULT UNDER THIS CONTRACT (INCLUDING ANY BREACH OF WARRANTY), SHALL BE LIMITED EXCLUSIVELY TO THE RIGHT TO REPLACEMENT OR REPAIR F.O.B. FIREYE MAIN WAREHOUSE LOCATION, AS ABOVE PROVIDED. IN NO EVENT SHALL FIREYE BE LIABLE FOR CONSEQUENTIAL OR SPECIAL DAMAGES OF ANY NATURE WHICH MAY ARISE IN CONNECTION WITH SUCH PRODUCT OR PART OR ANY BREACH OF OR DEFAULT UNDER THIS CONTRACT. TO THE EXTENT PERMITTED BY LAW, THE AGGREGATE LIABILITY OF FIREYE HEREUNDER WHETHER IN CONTRACT, TORT (INCLUDING NEGLIGENCE) OR OTHERWISE, WILL BE LIMITED TO ONE TIMES THE CONTRACT VALUE, PROVIDED HOWEVER THE FOREGOING LIMITATION DOES NOT LIMIT THE LIABILITY OF FIREYE FOR ANY INJURY TO, OR DEATH OF A PERSON, CAUSED BY THE GROSS NEGLIGENCE OF FIREYE.**