



NXD-6301  
October 15, 2019



# NEXUS NX6220 and NX6330 12-Key KEYPAD DISPLAY

## INTRODUCTION:

The Fireeye NX6220 or NX6330 (with Ethernet) OLED (**O**rganic **L**ED) 12 key keypad display provide an easy to read, bright operator interface for operation and commissioning of Fireeye NX6100 or PPC6000\* series control. The addition of four multi-function soft keys, make commissioning quicker and easier. Once in commissioning mode, these keys group related options, such as all servomotor options, together for convenience, minimizing the risk of skipping options that are related but in different areas of the program.

Two models are available; NX6220 (basic display with USB port) and NX6330 (USB and Ethernet port). Both displays include complete commissioning back up as well as three user defined relays. English, French and Spanish languages are supported and can easily be selected from a list of available languages stored within the display. Other languages may be added from time to time, consult the factory for availability.

The NX6330 Display also includes a choice of MODbus TC/PIP or BACnet integration into Building Automation Systems (BAS). See Fireeye Bulletin MOD-6001 for the appropriate register point lists.

The tactile membrane keypad provides a “click” feedback for positive key stroke entry. The lithium ion battery maintains the commissioned backup, clock, calendar and event log function in the event of power loss.

\* When used with the Fireeye PPC6000, the Fuel key will have no function as fuel selection is performed externally to the PPC6000.



Inside this bulletin:

## Contents

1. OLED (Organic LED) Display & Keypad .....	3
1.1 System Overview / Main Screen.....	5
2. Engineers Keys.....	6
2.1 Fault Log .....	7
3. Fuel (Profile) Selection .....	8
4. On/Off/Mode Selection .....	9
5. Data Key Mode .....	10
5.1 Profile Review Mode .....	11
5.2 Hours Run Mode .....	12
6. Commissioning/Profile Adjust.....	13
7. Setup Screen .....	14
7.1 Ethernet Setup Mode (Figure A).....	15
7.2 Ethernet Setup Mode (Figure B).....	15
8. How to Commission using the Text Display .....	16
8.1 Going into Commission Ratio mode .....	16
8.2 Using the Option Set mode.....	17
9. Backup and Restore From USB .....	18
9.1 Saving a Backup to USB.....	18
9.2 Viewing the contents of the USB drive .....	19
9.3 Restoring a Backup from USB.....	20
10. Specification for the FIREYE NX6220 or NX6330 12 key display .....	21
11. Fireye NX6220, NX6330 Mounting Details .....	22
12. Electrical Connections.....	23



## WARNING

EXPLOSION OR FIRE HAZARD  
CAN CAUSE PROPERTY DAMAGE,  
SEVERE INJURY OR DEATH

To prevent possible hazardous burner operation, verification of safety requirements must be performed each time a control is installed on a burner, or the installation modified in any way.

This manual may cover more than one model of the NX6100 control. Check for Additional Information at the end of this chapter.

## 1. OLED (Organic LED) Display & Keypad option

The OLED display supports plain text information in a variety of formats. This display is used for setting up the controller parameters and operating the boiler. The keypad is a membrane construction with tactile keys (you can feel the 'click') that gives a positive feedback of the actuation. This unit includes a lithium battery for the clock / calendar / event log functions.



Indication LEDs

### Function Keys 1-4

These keys will activate the function as displayed above on the OLED display

### Up/Down, Left/Right

These keys are used to navigate the menus and information displayed.



Key	Function
<b>EK</b>	Press this key to select the Status and <u>Engineer's Key Data</u> (EK) modes.
<b>Fuel</b>	Press this key to change the Fuel/Profile. If you change fuel when the burner is firing, the burner will go OFF and then restart, using the new fuel Profile. *
<b>On/Off/ Mode</b>	Press this key to switch the burner ON or OFF, and to enable changes between Normal and Local operation.  <i>Note: Terminal PE6 must be ON for this switch to start the burner.</i>
<b>Reset</b>	Press this key to mute (open) the alarm relays, and then press and hold the key down for approximately three seconds to reset the cleared faults.

\* The Fuel key will have no function when used with the Fireeye PPC6000.

When using the NX6220 and NX6330 displays, the password entry expects a 6 figure number, entered in two phases/sets. Press **F4** COM to enter Commissioning, Site, and Adjust Ratio passcodes. See examples below:

When entering Commissioning passcode with 000 displayed scroll up entering first phase/set then Press [ENTER ] scroll up entering second phase/set then Press [ENTER].

When entering passcode for Site and ADJ Ratio with 000 displayed press the right arrow key, then scroll up entering Site or Adjust Ratio passcodes then Press [ENTER].

Example:

000 Shown scroll up to XXX then Press [ENTER] scroll up to XXX [ENTER] equaling Commissioning.

000 Shown Press  then scroll up to XXX equaling Adjust Ratio number then Press [ENTER].

000 Shown Press  then scroll up to XXX equaling Site Passcode number then Press [ENTER].

To obtain Commissioning, Adjust Ratio, and Site Passcodes consult with Fireeye or OEM.

## 1.1 System Overview / Main Screen

The system overview is the default information displayed during normal operation of the burner.

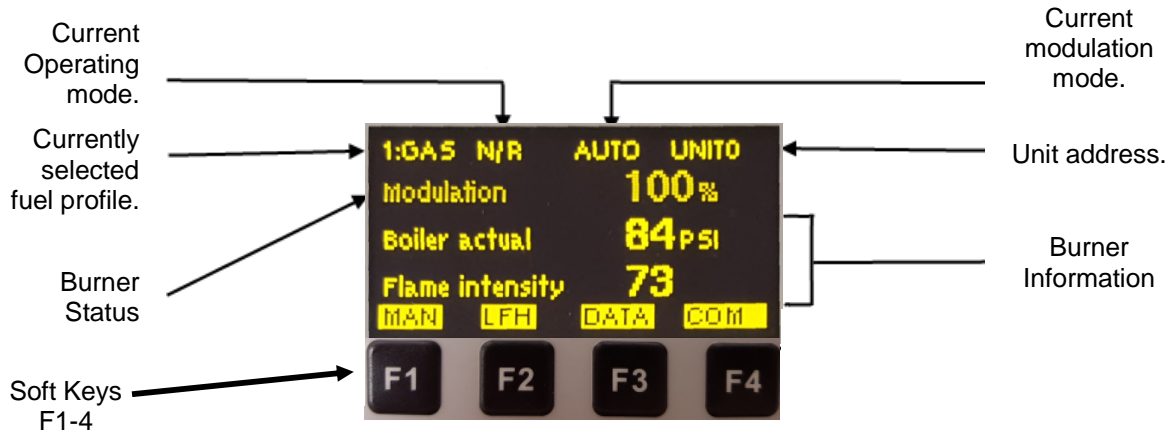

**System Overview Screen**

Key	Function
<b>F1</b>	Selects the modulation modes (AUTO, MAN).
<b>F2</b>	Selects the LFH (Low Fire Hold).
<b>F3</b>	Opens the Data screen, which shows further operational data of the control.
<b>F4</b>	Enters commissioning mode.



Note: The soft keys have multiple functions. The default functions are shown on the line above each key in the System Overview screen above. As you navigate through the various modes, the appropriate key functions will appear above each soft key F1 through F4.

## 2. Engineers Key

The engineers key is used to view the value or status of various control parameters. It is accessed using the Engineers Key on the keypad.

To enter: Press **EK** ,



At Engineers Key Screen, Scroll up  or Down  through the screen information.

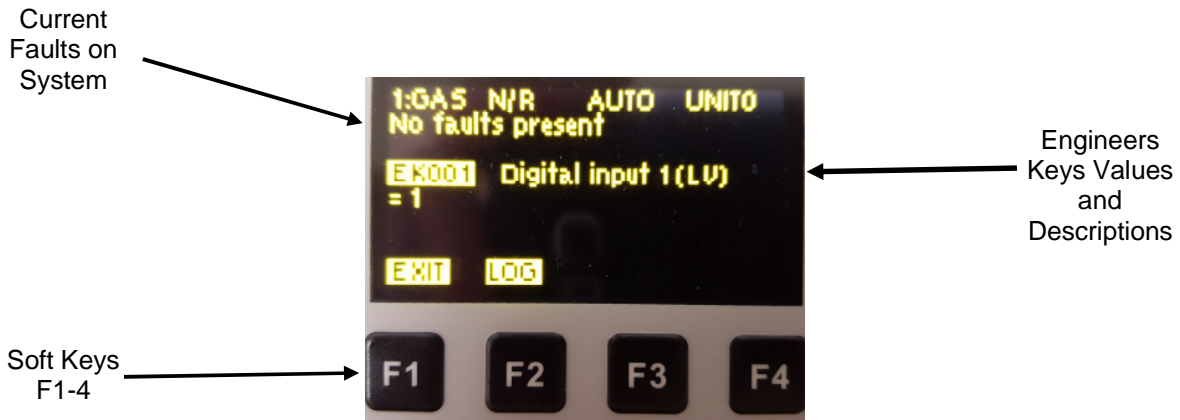

SEE Section 6 of Fireye Bulletin NEX-6101 or PPC6001 [Fault and Fault Finding] for Engineers Key Descriptions.

Key	Function
<b>F1</b>	Exit Engineers Key screen and return to the system overview.
<b>F2</b>	Displays the fault log for the display.



## 2.1 Fault Log

To Access from the Main Screen:

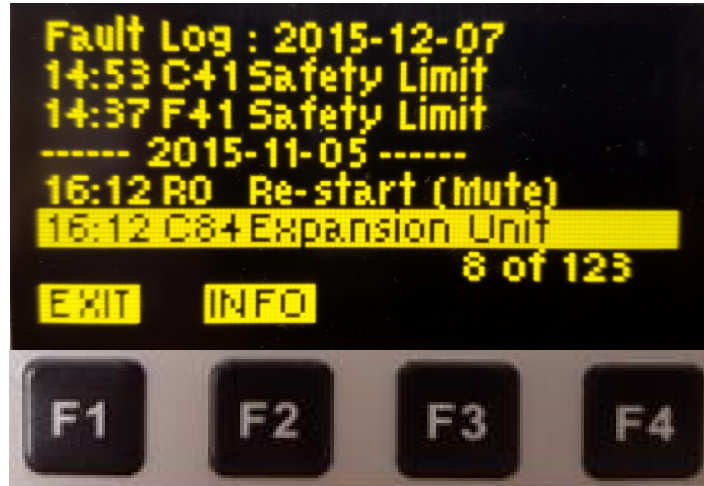
- 1) Press **EK** to access to the Engineers Key Screen
- 2) At Engineers Keys Screen, Press **F2** for LOG see screen below .



**NOTE:** Depending upon number of Logged faults, the operation in this table may seem sluggish. Please be patient. The entire log is populating

Key	Function
Up  Down 	SCROLLS through each line of the log.
<b>F1</b>	EXIT to return to system overview / main screen
<b>F2</b>	INFO – Pressing <b>F2</b> toggles between the line item and MORE DETAIL on that line item.

### 3. Fuel (Profile) Selection

This is the Fuel (profile) selection screen, it is used to switch between fuel profiles. It is accessed using the Fuel key on the keypad.

**NOTE: This Key has NO operation when an NX6220/6330 display is used with a PPC6000.**

To Access from the Main Screen:

- 1) Press **FUEL**
- 2) At the FUEL Screen below, Scroll up  $\triangle$  or Down  $\nabla$  to select Profile
- 3) Press **F4** for enter to select option,



Fuel (Profile) Selection Screen

Key	Function
<b>F1</b>	Go Back to the system overview display.
<b>F4</b>	Selects the current highlighted fuel profile.



## 4. On/Off/Mode Selection

The On/Off/Mode screen, is used to switch between burner operation modes and to turn the burner on and off. It's accessed using the On/Off/Mode key on the keypad.

To Access from the Main Screen:

- 1) Press On/Off/  
Mode
- 2) At the MODE Screen below, Scroll up  $\triangle$  or Down  $\nabla$  to highlight choice
- 3) Press F4 for ENTER to select option,

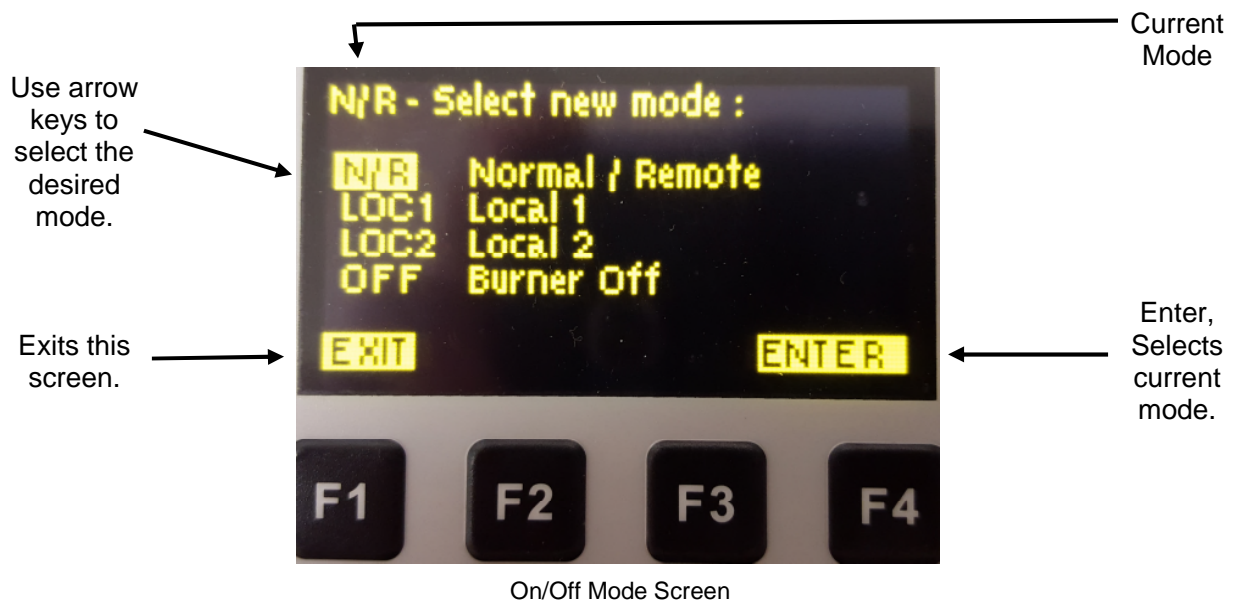

Key	Function
<b>F1</b>	Go Back to the system overview display.
<b>F4</b>	Selects the current highlighted burner mode.

## 5. Data Key Mode

This is the Data screen, which is used to view operating data, profiles and backup.

To Access from the Main Screen: Press **F3** for DATA,

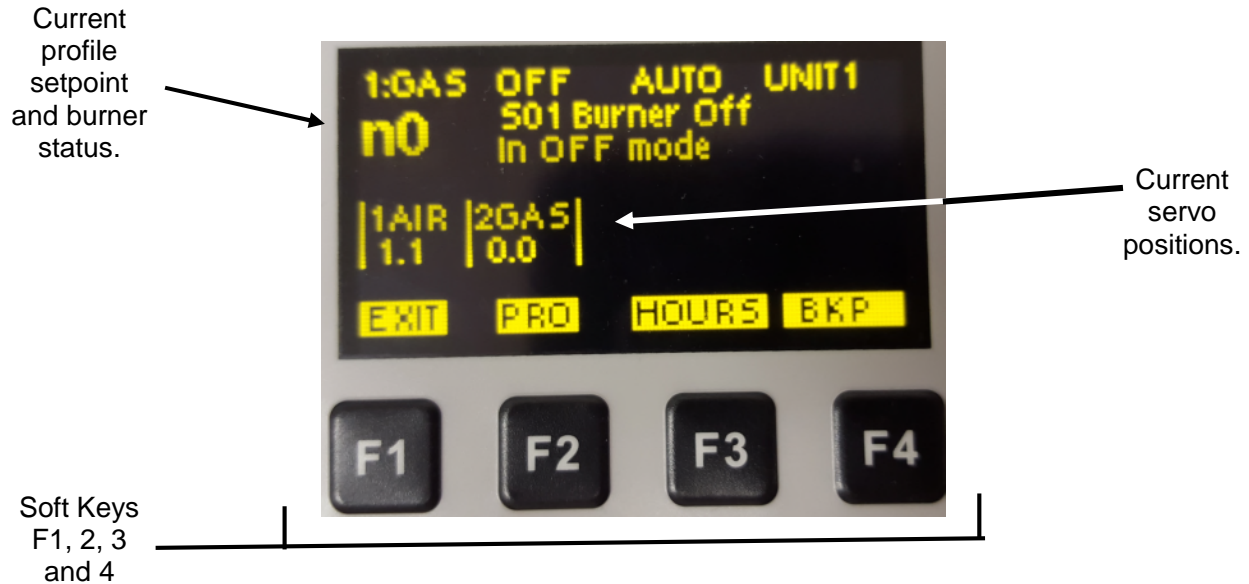



Key	Function
<b>F1</b>	EXIT to return to system overview / main screen
<b>F2</b>	PRO – displays ALL setpoints of each profile. See section 5.1 Profile Review Mode.
<b>F3</b>	HOURS – displays run time for ALL profiles. See section 5.2 Hours Run Mode.
<b>F4</b>	BKP (for BACKUP) – Shows details of currently saved backup. Pressing F3 for LOAD shows file folders on USB drive (inserted into port on display for saving backup).

## 5.1 Profile Review Mode

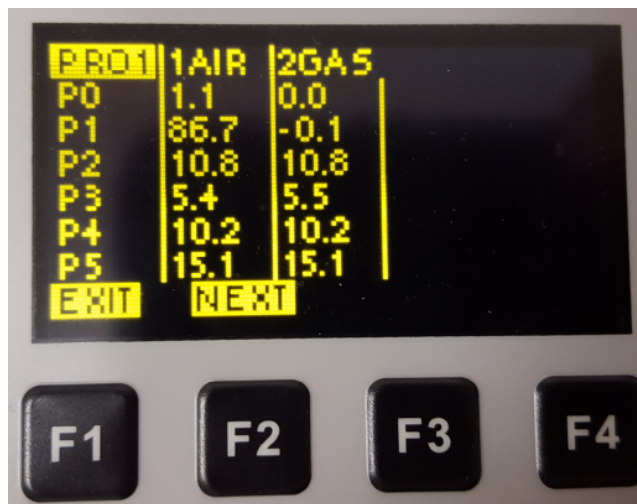
- 1) From the Main Screen: Press **F3** for DATA screen,
- 2) At the DATA Screen: Press **F2** for Profile, to show screen below,



Key	Function
Up  Down 	SCROLLS through ALL setpoints of the profile.
<b>F1</b>	EXIT to return to system overview / main screen
<b>F2</b>	PRO (PROFILE) – Pressing <b>F2</b> cycles through ALL of the profiles (in a loop). Each cycle displays ALL setpoints of that profile.

## 5.2 Hours Run Mode

This screen displays run time for ALL profiles

- 1) From the Main Screen: Press **F3** for DATA screen,
- 2) At the DATA Screen: Press **F3** for HOURS, to show screen below,

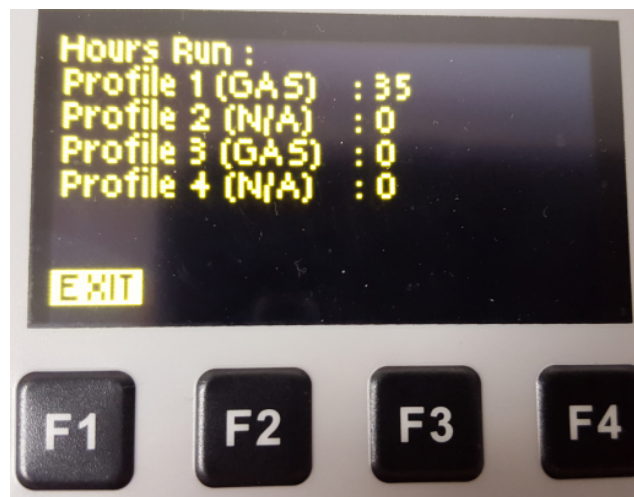

To Exit Press F1

## 6. Commissioning/Profile Adjust

**NOTE: SEE Section 5 in Fireeye Bulletins NEX-6101 or PPC6001 [Commissioning the Control] for details.**

This is the commissioning and profile adjust screen, they're used to adjust the option parameters and the profile setpoints.

To Access from the Main Screen: Press **F4** for Commissioning to get the screen below.

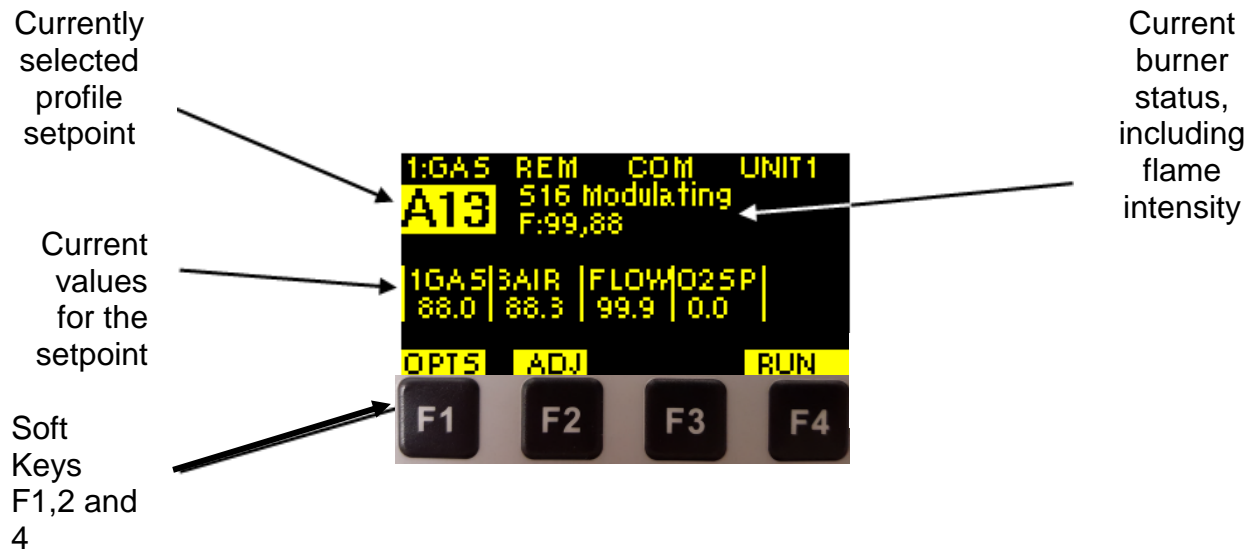

Profile Adjust Screen

Key	Function
<b>F1</b>	Access option parameters.
<b>F2</b>	Adjust values for the currently selected setpoint.
<b>F4</b>	Return to RUN mode, which exits Commission/Profile Adjust mode.

## 7. Setup Screen

The Setup screen, is used to set language, time, Ethernet, and unit address. (NX6330 Only)

To access:

- 1) From the Main Screen: Press **F4** for Commissioning screen,
- 2) At the Commissioning Screen: Press **F1** for Options, to show screen below,

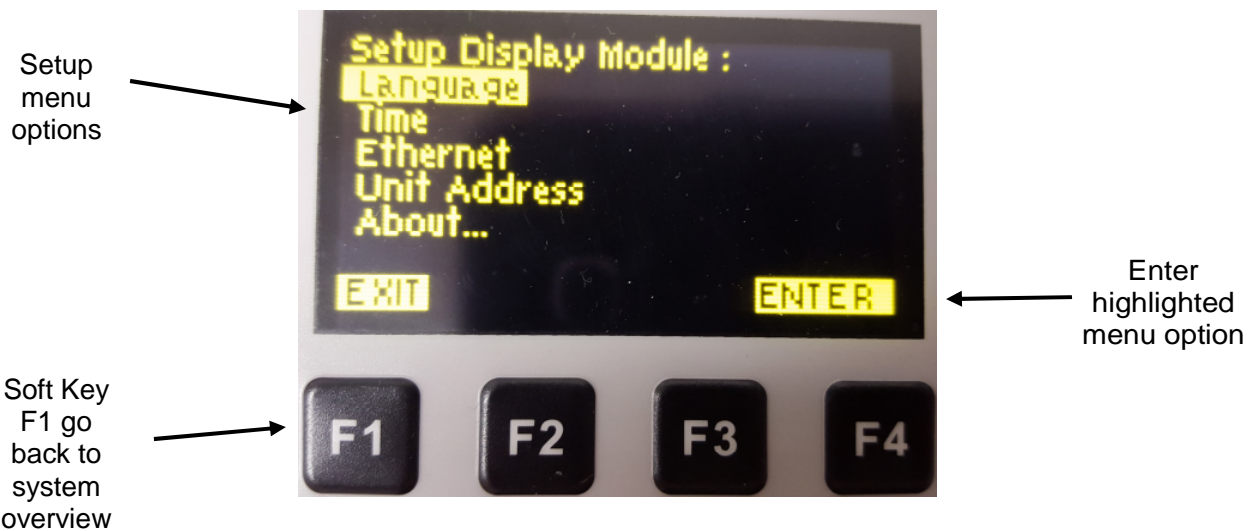

Key	Function
F1	Return to system overview.
F4	Enter highlighted menu selection.

For **NX6220** date and time settings see option parameters in the NX6101 or PPC6001 manuals.

To access Screens 7.1 or 7.2: (NX6330 Only)

- 1) From the Main Screen: Press **F4** for Commissioning screen,
- 2) At the Commissioning Screen: Press **F1** for Options, to show screen below,
- 3) At the Options Screen, Scroll Down  $\nabla$  to highlight Ethernet
- 4) Press **F4** for ENTER to select option,

### 7.1 Ethernet Setup Mode (Figure A)

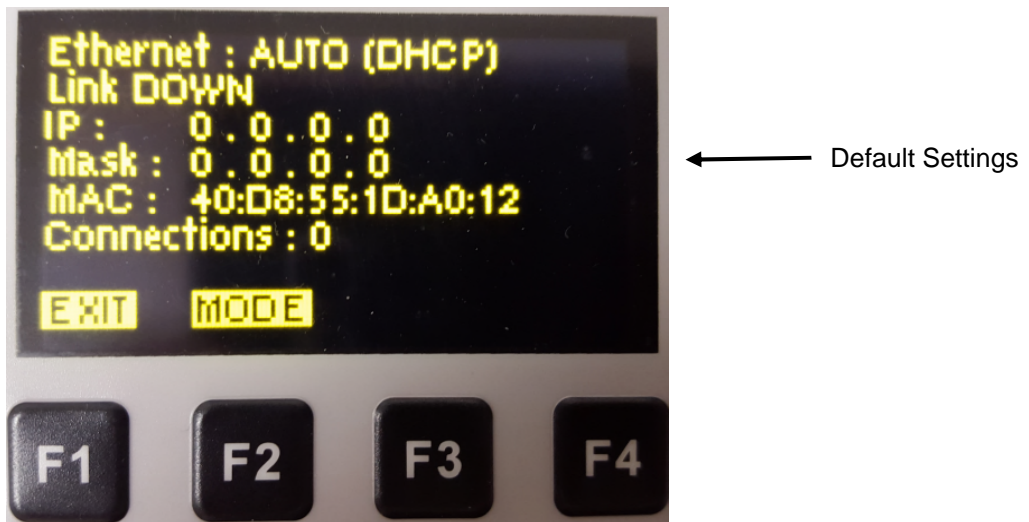

### 7.2 Ethernet Setup Mode (Figure B)

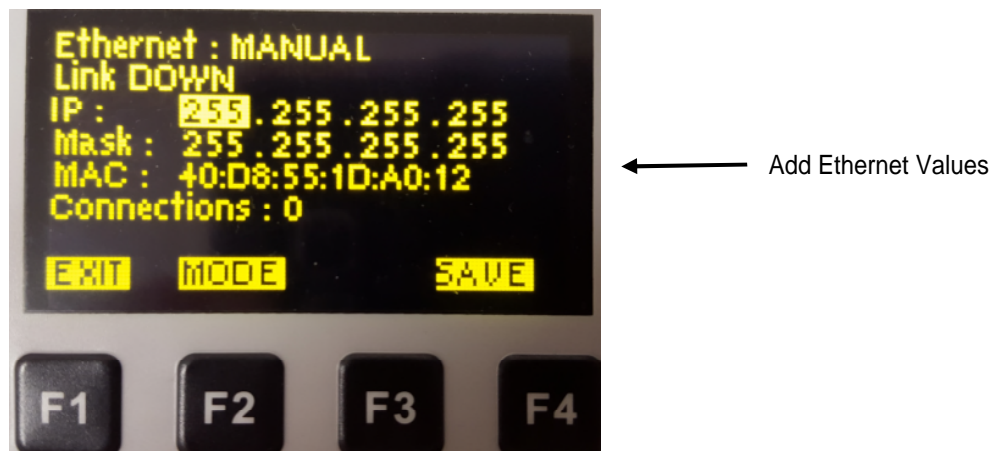

## 8. How to Commission using the Text Display



Example text display. The printed fascia may be different, but the display and keys are the same.

### 8.1 Going into Commission Ratio mode

Commissioning the Fuel/Air Ratio refers to entering the set point data that defines the curves in the Profile(s).

- First, stop the burner. Press [On/Off] select 'OFF' then press ENTER [F4].
- After the burner has completely shut down, press the **COM** key. You now have 30 seconds to enter the passcode number.
- Use the **UP/DOWN** arrow keys to scroll to the first three-digit passcode number, then press **ENTER** .
- Repeat to enter the second three numbers, then press **ENTER**.  
Here are the steps:

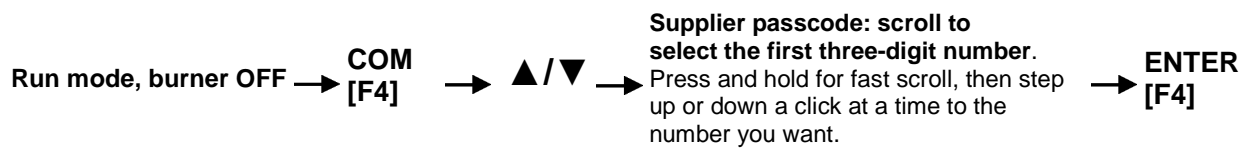





↳ ▲/▼ → Supplier passcode, scroll to select the second three-digit number → ENTER [F4]

If you entered the correct passcode, the display top line will show **COM**, and the next line will show **P0**, which represents the Closed position set point.

**NOTE:** Be sure ALL Previous Faults are **CLEARED**. Otherwise, you will NOT be able to advance.

### 8.1.1 Changing from Commission / Adjust Ratio mode to Option Set mode

To enter the Option Set mode, first enter Commission Ratio mode or Adjust Ratio mode (see section 5 "Commissioning The Control" in the PPC6001, and NX6001 manuals) and press the **OPTS** key.

Commission / Adjust Ratio mode > OPTS [F1] > Option Set mode

### 8.1.2 Changing from Option Set to Commission / Adjust Ratio modes

To change from Option Set mode to Commission Ratio mode, press the **EXIT** key.

Option Set mode → EXIT [F1] → Commission ratio / Adjust Ratio mode

### 8.1.3 Exiting from Commission mode

To exit from any Commission mode you must be in the Commission/Adjust Ratio display mode, then press the key labelled **RUN** and then **EXIT**. For example:

Commission ratio / Adjust Ratio mode > RUN [F4]> EXIT [F4] > Run mode

## 8.2 Using the Option Set mode

You can set up or adjust the various Option parameters given in section 5.

- Go into Option Set mode as described in section 8.1.1 above
- Use the ▲/▼ UP/DOWN keys to select the Option parameter to be adjusted. The Option parameter number is shown with a description on the first line, and the value in the second line:

Example at Option parameter = 1.0 and value 5:

1.0 PowerUp Option = 5 (0 to 360)
--------------------------------------

- Use the **ADJ** and **BACK** keys to toggle between the top row (Option number) and the bottom row (Option value).
- Use the ▲/▼ UP/DOWN keys to set or change the value of the option parameter. When the correct value is selected, press the **ENTER** key to store the new value.

Repeat the process to select another Option parameter, and set or adjust the values as necessary. When you have finished, exit from Option Set mode.

## 9. Backup and Restore From USB

### 9.1 *Saving a Backup to USB*

9.1.1 Press the DATA key, then BKP, to view the backup status screen. Verify that a backup is stored in the display – look for the words “BACKUP COMPLETE”.



```
Commission Backup : Verified
Verified : 100.0 %
Date of last backup image:
2016/03/22 10:08:59
BACKUP COMPLETE
EXIT  SAVE
```

9.1.2 Insert a USB drive into the connector at the side of the rear cover. Press the SAVE to see the folder list on the USB. It will be displayed like this:



```
Save USB :
/Folder 2
/Folder 1
EXIT  BACK  ENTER  SAVE
```

9.1.3 You can navigate to a folder using the ▲ ▼ and ENTER keys. To save the backup to the current folder press SAVE. If the save is successful then the message BACKUP COPIED OK will flash on the display.

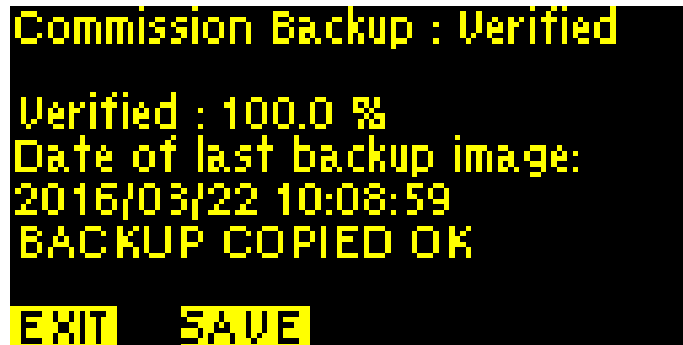

## 9.2 Viewing the contents of the USB drive

9.2.1 When viewing the contents of the USB drive on a PC, the file name of the backup files will be in the following format :

**UNITADDRESS\_YYYY-MM-DD\_HH-MM-SS.CBU**

As shown below.

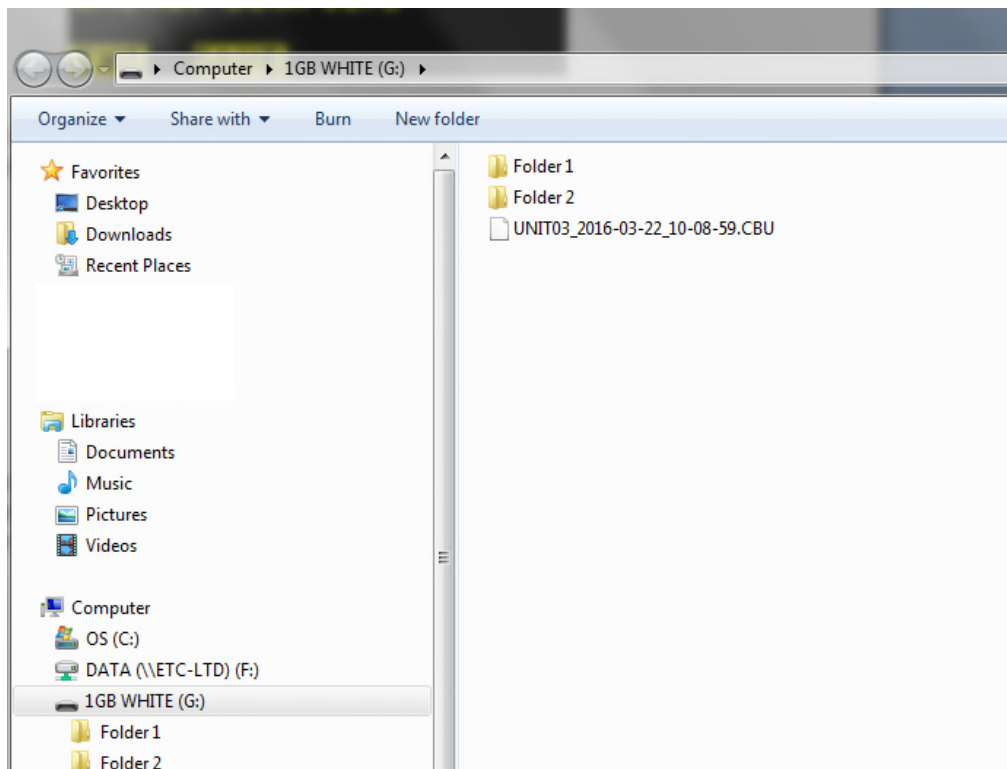

### 9.3 Restoring a Backup from USB

9.3.1 Ensure that the burner is OFF. Press the DATA key, then BKP and LOAD. This will show the USB file structure as follows:

```
Load USB :
UNIT03 2016-03-22 10-08-59.
/ Folder 2
/ Folder 1

1. EXIT  BACK  LOAD
```

9.3.2 You can navigate to a folder using the ▲ ▼ and ENTER keys. Once the desired backup file is highlighted, ensure that the unit address matches the current unit, and then press LOAD. If the load is successful then the message BACKUP COPIED OK will flash on the display.

```
Commission Backup : Verifying

Verified : 0.0 %
Date of last backup image:
2016/03/22 12:39:23
BACKUP COPIED OK

2. EXIT  SAVE  LOAD
```

9.3.3 The backup can now be restored to the controller using Option Parameter 45.x, as per section 4.2 in section 3 of the product manual.



## 10. Specification for the FIREYE NX6220 or NX6330 12 key display

Electrical, environmental and mechanical details of the 12 key display unit.

Interface Type	CANbus																
Supply current	75 mA																
Ambient temperature range	0 - 60 °C (32 - 140 F)																
Touch screen protection category	IP65 screen/bezel to panel IP20 electronics behind panel																
Mounting attitude	Any																
Number of relays	3																
Relay Type	<table border="1"> <thead> <tr> <th>Relay</th> <th>C</th> <th>NO</th> <th>NC</th> </tr> </thead> <tbody> <tr> <td>1</td> <td>3</td> <td>1</td> <td>2</td> </tr> <tr> <td>2</td> <td>7</td> <td>5</td> <td>6</td> </tr> <tr> <td>3</td> <td>7</td> <td>9</td> <td>8</td> </tr> </tbody> </table>	Relay	C	NO	NC	1	3	1	2	2	7	5	6	3	7	9	8
Relay	C	NO	NC														
1	3	1	2														
2	7	5	6														
3	7	9	8														
Maximum relay current	6 A 250 V rms																
Minimum relay current	100 mA																
Unit dimensions	height x width x depth  6.22"(158mm) x 5.67"(144mm) x 2.20"(56mm)																
Weight	0.55 kg																

### Wire Chart

All low voltage wiring must be braided type. Foil wrapped wire is not acceptable. The wire listed below is the only acceptable wire. Shielded wire should not be used for the line voltage terminals.

	Alpha (Conductors)		Belden (Conductors)		Harting (Conductors)	
	4	2	4	2	4	2
300v	25164	25162	9940			
600v	25524	25522	7895A*		0945600 0102	

Belden 7895A requires 2 conduit adapters per device.

## 11. FIREYE NX6220, NX6330 MOUNTING DETAILS

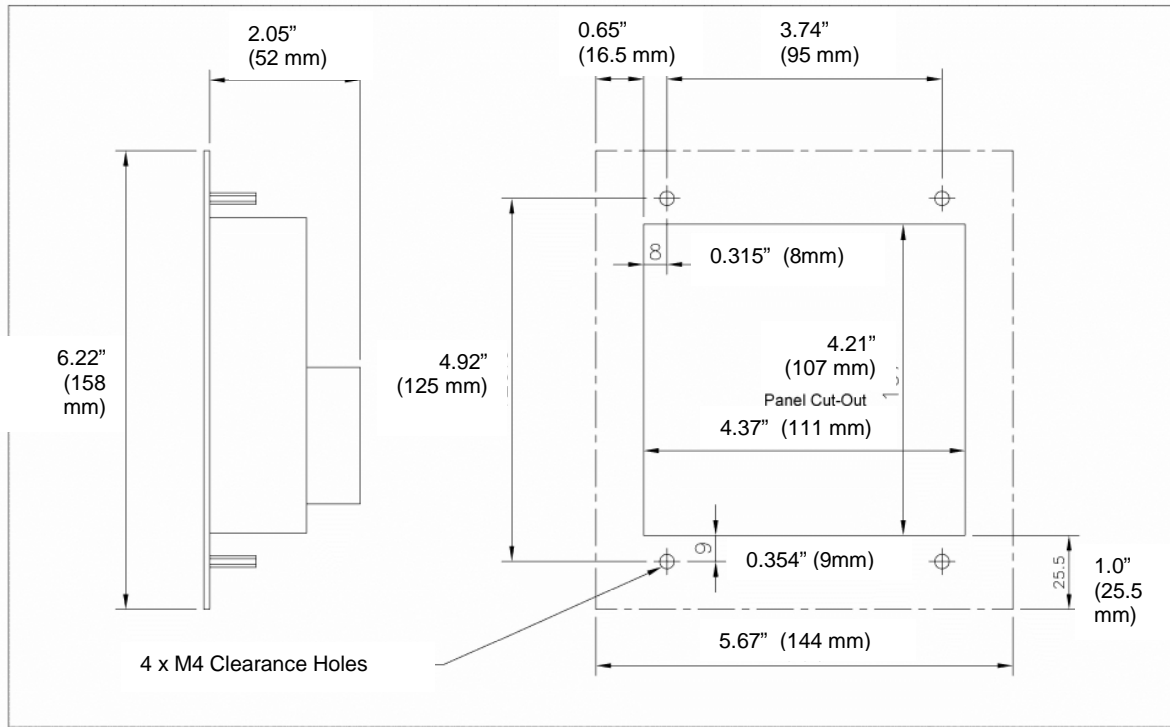

**NOTE:** Cut out dimensions of the NX6220, NX6330 and NX610 are slightly larger than the NX6110. Mounting holes are the same location as the NX6110, but not the NX610 (9 key) display. Cut out is approximately 5/16" larger vertically, 1/8" wider horizontally.

## 12. Electrical Connections



Relay Terminals PR1 thru PR9

Ground Termination

T1 & T2 24Vac  
T3+ & T4- CANbus

Display Relay Outputs

Display Terminals

NX/PPC Terminals

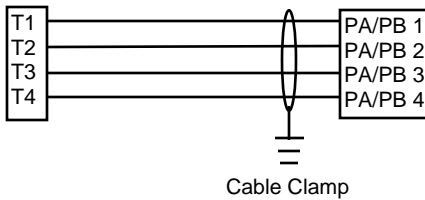

PR1	Relay 1 Normally Open
PR2	Relay 1 Normally Closed
PR3	Relay Outputs 1 Common
PR4	No Connection
PR5	Relay 2 Normally Open
PR6	Relay 2 Normally Closed
PR7	Relay 2 & 3 Common
PR8	Relay 3 Normally Closed
PR9	Relay 3 Normally Open

Voltage Free Dry Contacts

### Ethernet and USB Connection



Ethernet Connection NX6330 Only

USB Port

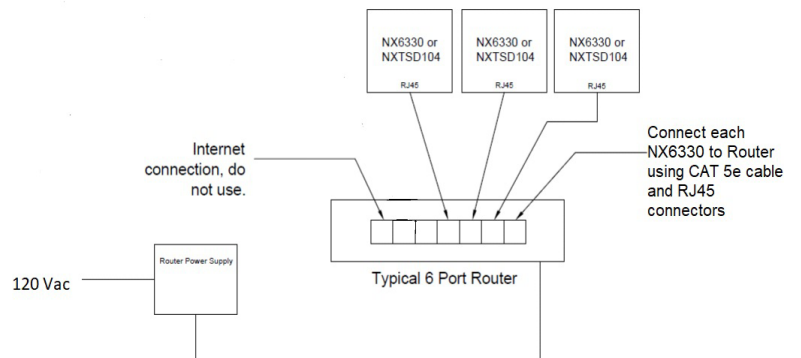



---

## NOTICE

When Fireeye products are combined with equipment manufactured by other and/or integrated into systems designed or manufactured by others, the Fireeye warranty, as stated in its General Terms and Conditions of Sale, pertains only to the Fireeye products and not to any other equipment or to the combined system or its overall performance.

---

## WARRANTIES

FIREYE guarantees for *one year from the date of installation or 18 months from date of manufacture* of its products to replace, or, at its option, to repair any product or part thereof (except lamps and photocells) which is found defective in material or workmanship or which otherwise fails to conform to the description of the product on the face of its sales order. **THE FOREGOING IS IN LIEU OF ALL OTHER WARRANTIES AND FIREYE MAKES NO WARRANTY OF MERCHANTABILITY OR ANY OTHER WARRANTY, EXPRESS OR IMPLIED.** Except as specifically stated in these general terms and conditions of sale, remedies with respect to any product or part number manufactured or sold by Fireeye shall be limited exclusively to the right to replacement or repair as above provided. In no event shall Fireeye be liable for consequential or special damages of any nature that may arise in connection with such product or part.



Fireeye Inc.  
3 Manchester Road  
Derry, NH 03038  
[www.fireeye.com](http://www.fireeye.com)

NXD-6301  
October 15, 2019  
Supersedes January 23, 2019