



FS950W

Communication Software

for Fireeye® 95IR/95UV/95DS InSight Scanners and
45FS1/45UVFS1 Flame Signature™ Scanners using
a Windows Based Operating System

DESCRIPTION

The FS950W is a Windows based software program designed to expand on the capabilities of the 95IR/95UV/95DS InSight and 45FS1/45UVFS1 Flame Signature Scanners. The software program requires an IBM compatible PC and allows the user to communicate with the scanners to provide the following capabilities:

- Communicate with up to 128 scanners wired in a multi-drop wiring configuration via RS485.
- Upload/download flame Signature configuration files to/from an IBM compatible PC (45FS1/45UVFS1 scanners only).
- Create flame signal bar graphs (up to 12 bargraphs per screen).
- Review real time flame signal trend log.
- Review Fast Fourier Transform of flame signal spectrum.
- Review time (oscilloscope) readout of flame signal, and flame signature configuration files.
- Review/program scanner setpoints remotely.

To assist the user in the operation of the scanner and this software program, the technical bulletins for the InSight Scanners (CU-95) and for the Signature Scanners (CU-32, CU-33) should be reviewed.

HARDWARE REQUIREMENTS

The following represents the **minimum** hardware requirements for an IBM¹ compatible PC to run the FS950W communications software program:

- Windows² 95, 98: 32 MB memory
- Windows NT: 64 MB memory
- Color monitor with 600 x 800 resolution
- One communications (COMM) port
- RS232 serial I/O port and RS232 to RS485 converter³

SOFTWARE REQUIREMENTS

Windows Based Operating System

¹ IBM is a registered trademark of International Business Machines, Inc.

² Windows is a registered trademark of Microsoft.

³ Fireeye recommends using either P/N EC485 or IC485 (optically isolated) RS232 to RS485 converter. Each includes a 110VAC to 12VDC power supply.



TABLE OF CONTENTS

Description	1
Hardware Requirements	1
Wiring the Scanners for Communications	3
Installing the FS950W Software	5
Software Overview	6
Getting Started.....	6
Menus	8
Password.....	12, 25
Toolbar.....	14
Database	15
Site Information.....	15
Units Set-Up	16
Bargraphs Setup	17
Print Function.....	18
Scanner Configuration Screen.....	19
Saving/Loading Configuration Files	22
Overview Screen	22
Keypad/Display Screen	25
Bargraph Screen	27
Graph Screen	29
FFT Graph	29
Trend Graph	34
Time Graph (Oscilloscope)	37

WIRING THE SCANNERS FOR REMOTE COMMUNICATIONS

The scanners can be connected to an IBM compatible PC to allow the user to review flame status, system setpoints, and other operational information. The individual flame scanners are connected via a data link (a single, twisted shielded pair wire, e.g.: Belden 8761) in a multi-drop (e.g.: daisy chain) wiring configuration. **Refer to bulletins CU-95 (InSight) or CU-32 (Signature) for wiring scanners in a multi-drop configuration.** The flame scanners are then connected to a IBM compatible PC.

Up to 128 scanners can be connected on a data link. However, when more than 32 scanners are connected together, or the total length of the data link exceeds 4,000 feet, repeaters (or amplifiers) are required to boost the signal. Consult the factory for information on the use of repeaters. The communication address of each scanner is programmed via the keypad/display of the scanner under the Setpoints menu. The mnemonic code = **COMM** (Communication Address). **NO TWO SCANNERS CAN HAVE THE SAME COMMUNICATION ADDRESS.**

DIRECT CONNECT

The scanners communicate over the data link via RS485. An RS232/RS485 converter is required for the RS232 Serial Comm Port of the IBM PC. Fireye recommends using either P/N EC485 or IC485 (optically isolated) RS232 to RS485 converter. Each includes a 110VAC to 12VDC power supply.

EC485 WIRING

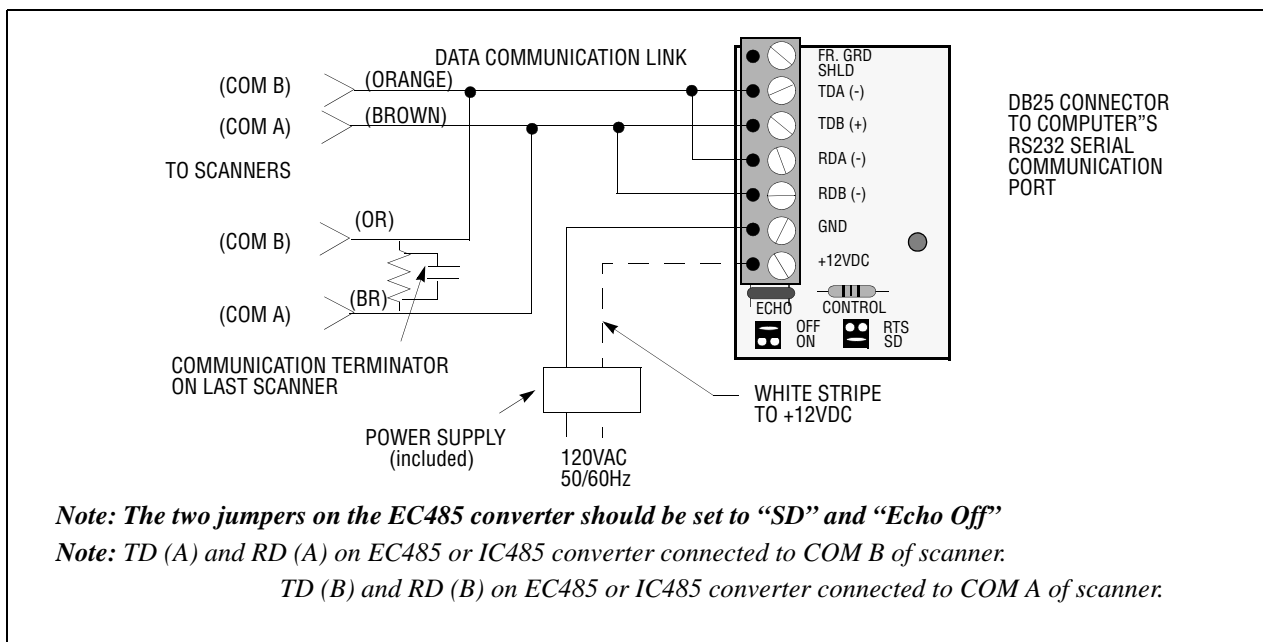

IC485 WIRING

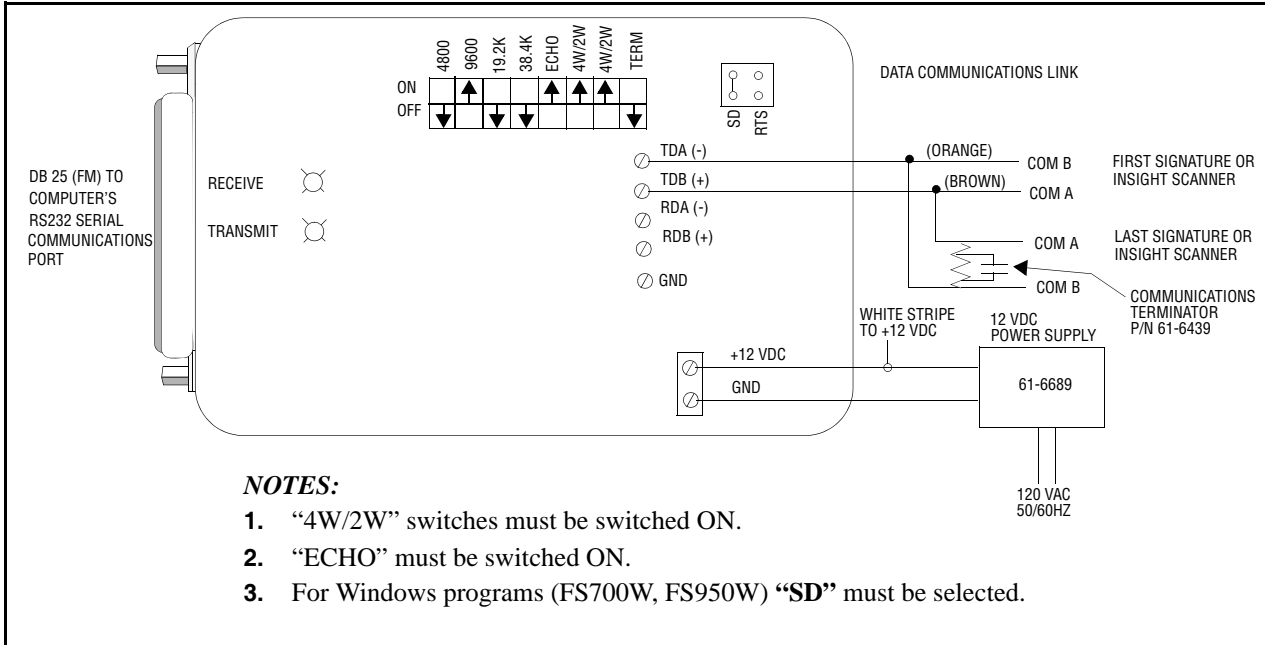

COMMUNICATION TERMINATOR

The communication terminals on the scanner must be terminated with the proper components to avoid signal distortion and communication errors. The FS950W software is packaged with a line terminator.

Line Terminator - 150 ohm resistor in parallel with a 0.047 microfarad capacitor. (P/N 61-6439).

The Line Terminator (P/N 61-6439) should be connected to the last scanner in a multi-drop configuration (e.g.: at the end of the data link) as shown in the figure on the following page.

To make your own terminators: Line terminator is a 150 ohm resistor in parallel with a 0.047 microfarad capacitor. Solder their internal connections and insulate securely with shrink tube or tape.

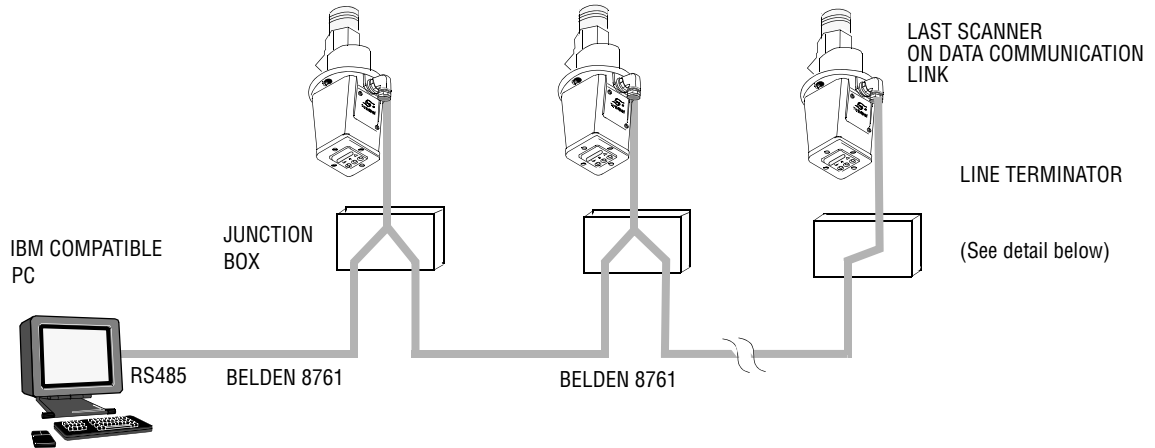

- Signature[®] Scanners shown.
- Wiring to flame amplifier (Signature Scanner only) not shown.
- Shields on individual wiring runs of Belden 8761 connected together and taped.
- Shield of Belden 8761 at IBM PC connected to ground.

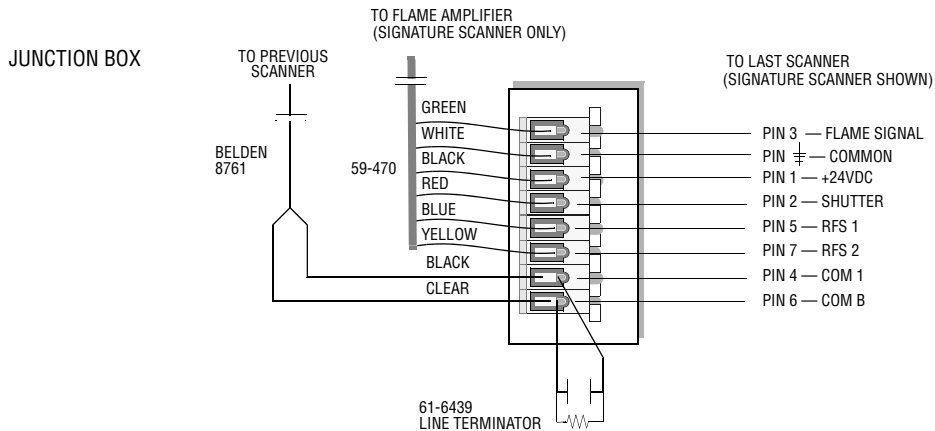

INSTALLING THE FS950W SOFTWARE

1. Install P/N FS950W-1 CD-ROM
2. You will see “Copying files, please stand by”.
3. You will be prompted to close any open applications.
4. You will be prompted to either accept C:\Program Files\FS950W as the destination directory, or you may change the destination.
5. You will be prompted to choose a “Program Group”. The default will be “FS950W”.
6. When complete, you will be prompted “FS950W Setup was completed successfully”.



SOFTWARE OVERVIEW

Following is a brief description of the available option screens:

SYSTEM OVERVIEW - Displays the flame on/off status of all of the connected scanners (up to a maximum 128).

REMOTE KEYPAD - Displays an operational graphic of the keypad/display located on the rear of the scanner. Up to 12 keypads may be displayed simultaneously.

TREND GRAPH - Trends the flame signal parameters versus time.

FFT GRAPH- (FAST FOURRIER TRANSFORM) - Displays the Fast Fourier Transform (or frequency spectrum) graphic of the flame signal.

TIME GRAPH (OSCILLOSCOPE) - Displays the flame signal as seen using an oscilloscope.

SCANNER CONFIGURATION FILES - Displays the information associated with each of the memory files within each scanner. This screen also allows the user to upload and download the files to/from an IBM PC to a Signature scanner (not available with InSight scanners).

BARGRAPH SCREEN(S)- Displays a flame signal bargraph, as well as flame “quality” and temperature for up to 12 scanners per screen.

GETTING STARTED

When the FS950W is installed and opened for the first time, the user will be prompted to enter the “COMPANY NAME” and the FS950W software “SERIAL NUMBER”. The serial number is printed on the original CDROM. These fields must be completed before the software will operate.

To activate the FS950W software and gain access to all its features you must first:

1. CREATE and OPEN a “Database.”
2. ADD a “Site.”
3. CONNECT to a Site and SET-UP the “Units” at the Site.
4. SET-UP “Bargraph” screen(s).

CREATE and OPEN a “Database”

Left mouse click on “DATABASE”

Left mouse click on “CREATE”

Type in a data base name, e.g. “XYZ POWER COMPANY”

Left mouse click on “OPEN”

ADD a “Site”

Left mouse click on “SITE”

Left mouse click on “ADD”

Type in a site “DESCRIPTION” e.g. “BOILER No. 1”

Verify that the Baud Rate is set at “9600” and the Parity at “NONE”

Verify that the appropriate computer communications “PORT” is selected

Left mouse click on “SAVE”

CONNECT to a Site and SET-UP the “Units” at the Site

Left mouse click on “SITE”

Left mouse click on “CONNECT”

Select the site to be connected (e.g. Boiler No. 1) and click on “OK”

The software will now display the “Setup Units / Units at site” screen.

You may now manually enter the communication addresses, and scanner “type” of all the scanners on Boiler No. 1. (You may alternately use the “DISCOVER” and “VERIFY” functions detailed later in this document).

You must manually enter a “DESCRIPTION” for each unit, e.g. B1A (representing burner 1A scanner).

When the “UNITS at SITE” screen is completed, click on “SAVE”. The software will then check the online/offline status of all listed scanners.

Click on “OK” to exit the screen.

The FS950W main screen will now be displayed.

At this time you may view the various OVERVIEW, KEYPAD, GRAPH, and CONFIGURATION screens for all scanners identified on the “Units at Site” screen.

SET-UP “Bargraph” Screens.

To create BARGRAPH screens, left mouse click on “SETUPS” then “BARGRAPHS.”

The “BARGRAPH SELECTIONS” screen will now be displayed showing all scanner addresses and descriptions identified on the “Units at Site” screen.

Type in a Bargraph screen “name”, e.g. “LEVEL 1”. The user may either manually type in the “LOCATIONS” and click on the “SELECT” column as described below or may instead **click and drag the individual “ADDRESS” to the desired “LOCATION.”**

Type in the “LOCATION” (positions) where you would like the individual bargraphs to appear on the bargraph screen, e.g. type “11” in the “LOCATIONS” column next to the appropriate “description” if you want a bargraph to appear in the middle of the screen.

Left mouse click in the “SELECT” column to confirm the location. You may place up to 12 bargraphs on one bargraph screen. Avoid locating two scanners adjacent to each other (e.g. locations 11 and 12) as they will overlap.

When you have completed the first bargraph screen, click on “SAVE.” You may create as many bargraph screens as necessary. To create an additional bargraph screen click on “New Screen” in the pull-down menu where the Bargraph screen name appears.

When all bargraphs are complete, click on “CANCEL ” to exit the screen.

The FS950W main screen will now be displayed.



FS950W MENUS

The Menus contain all the options and functions available to the user. Each Item on the menu will drop down to show the sub-items under each major heading. When the program is started and no site has been connected the sub-items under the major items of “Setups” and “Displays” will be disabled since they require a connection to a Site. On the initial use of the program before a database has been created the “Site” Menu item will also be disabled because the database is the entity that contains the Sites. Once the database has been created and selected, and the Site has been connected, all the menu items are active.

The FS950W Software is controlled by the menus and toolbar buttons that appear at the top of the screen.

File

The “File” Item drops down to show “Print,” “Close Keypads,” and “Exit.”

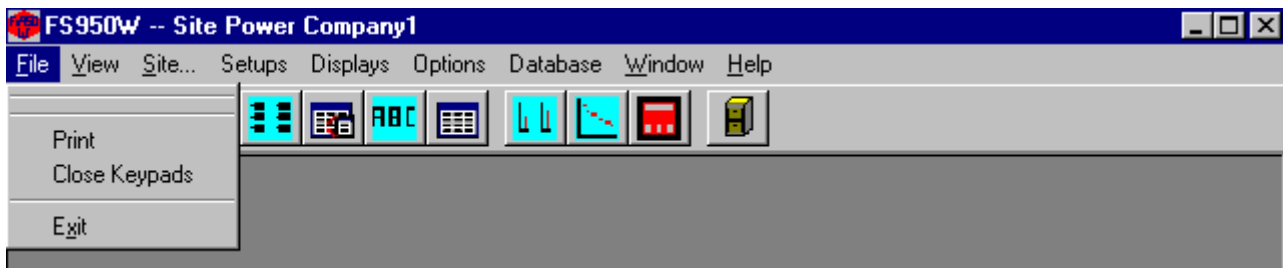

Print

The “Print” Item will print the currently active screen.

Close Keypads

The “Close Keypad” Item allows the user to close all the keypads at once. There could be up to 12 of these keypads open at one time.

Exit

The “Exit” Item will close the program.

View

The “View” Item drops down to show “Toolbar” and “Status bar.””



Toolbar

The “Toolbar” Item toggles the Toolbar on and off.

Status bar

“Status bar” Item toggles the “Status bar” on and off.

Site

The “Site” Item drops down to show “Connect,” “Disconnect,” “Add,” “Modify” and Remove.”

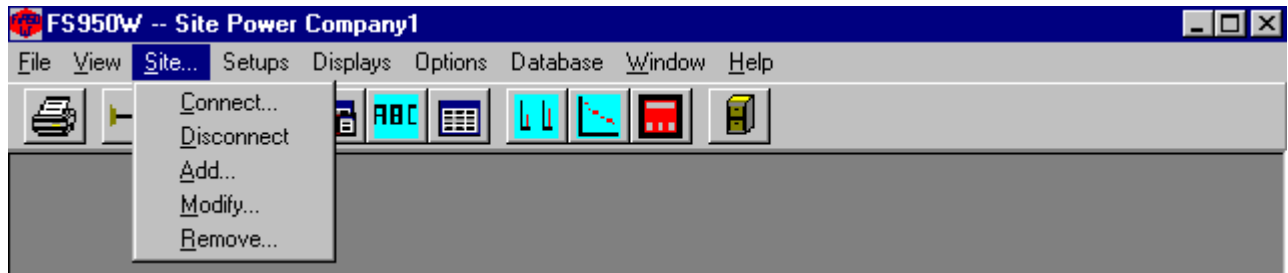

Connect

The “Connect” Item sets up and opens the serial port for communication with the scanners. If a Site was previously opened it will be closed along with all the open screens before the new Site is Opened.

Disconnect

The “Disconnect” Item closes the serial port and any open screens.

Add

The “Add” Item creates another site in the database.

Modify

The “Modify” Item allows the parameters of the selected Site to be changed. Any changes made will not take effect until the Site is “Connected” again.

Remove

The “Remove” Item deletes a Site from the database.

Setups

The “Setups” Item drops down to show “Bargraphs” and “Units.”



Bargraphs

The “Bargraphs” Item allows the selection and positioning of scanners on the bargraph screen.

Units

The “Units” Item allows the setup and identification of all the scanners that are connected.

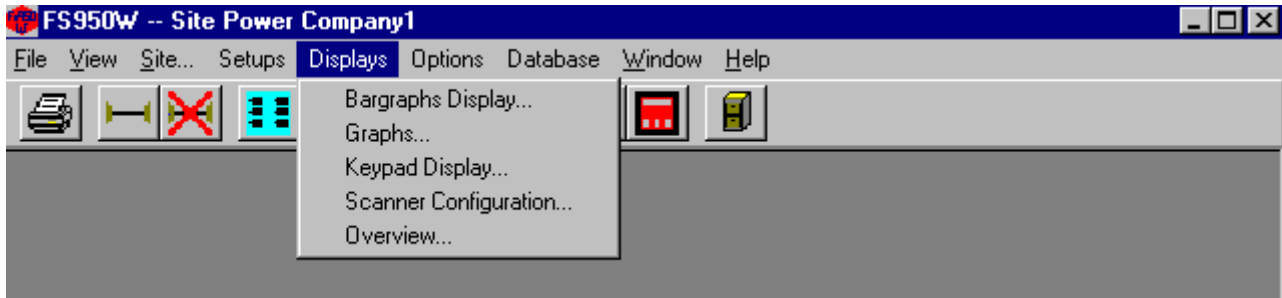

Displays

The "Displays" Item drops down to show "Bargraphs Display," "Graphs," "Keypad Display," "Scanner Configuration" and "Overview."

Bargraphs Display

The "Bargraphs Display" Item shows the Flame On/OFF bargraph screen.

Graphs

The "Graphs" Item allows the user to view the FFT, Trend, and Time Graphs for the available scanners. Up to 4 graphs can be open at one time.

Keypad Display

The "Keypad Display" Item shows the remote keypad which can be used for the programming of an individual scanner. Up to 12 keypads can be open at one time.

Scanner Configuration

The "Scanner Configuration" Item allows for the display, editing and saving of the internal scanner files.

Overview

The "Overview" Item shows the status and parameters for all scanners in the system.

Options

The "Options" Item drops down to show "Temperature Units," "Colors," "Logging," "Change Password" and "Alarm."

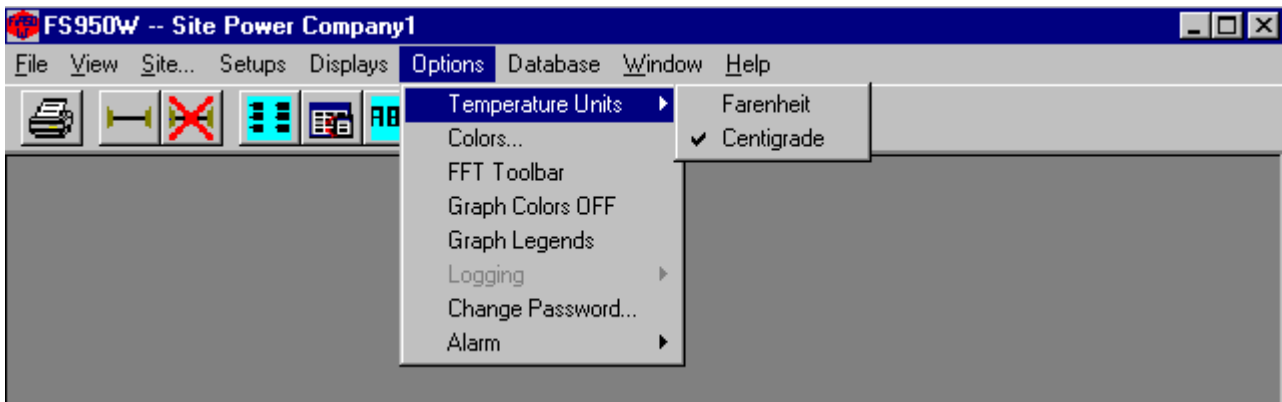

Temperature Unit

The "Temperature Units" sub-item allows the user to choose either Fahrenheit or Centigrade for displayed temperatures.

Colors

“Colors” allows the user to select the colors and line styles for each of the scanners shown on the “Graphs,” “Bargraphs” and the “Overview” screens.

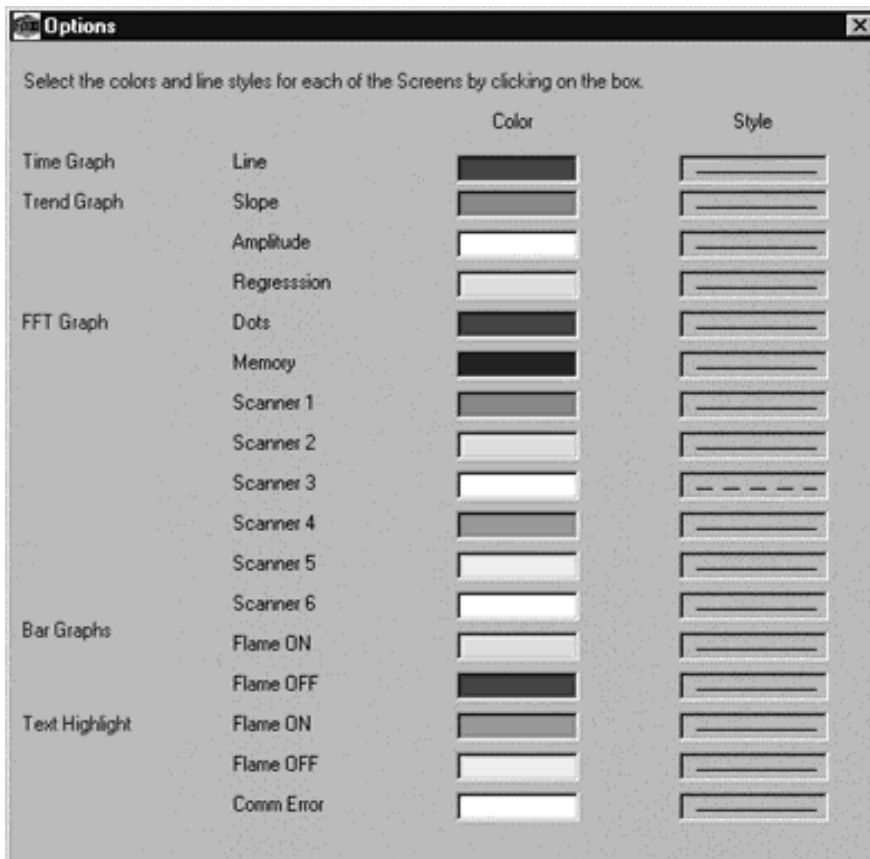

The colors and line styles are saved in the Windows registry and remain with the PC and not the database.

FFT Toolbar

When viewing the FFT screen, this selection allows the user to change the FFT background color and engage 3D views.

Graph Colors OFF

If you select a custom color for the Graph screens, then later decide you prefer the default Windows color, click on Graph Colors OFF. You must then close the screen and then re-open it for the change to take effect.

Graph Legends

When viewing more than one scanner on the FFT screen, this selection allows the user to display the color code/description for the selected scanners.

Logging

The “Logging” function is active only when the “OVERVIEW” or “Bargraph” screen is running. (Refer to “Overview” and “Bargraph” screen sections).

Change Password

The initial value of the Password is “fireye.” The “Change Password” Item allows the user to set the password that is used in the “Keypad” and “Scanner Configuration” Screens. Passwords are case sensitive.

Alarm

“Alarm” allows the user to turn on and off the Alarming features for the “Overview” screen. The Alarm drops down to show “Overview Alarming On” and “Set Overview Alarm Values.” (See “Overview” screen section).

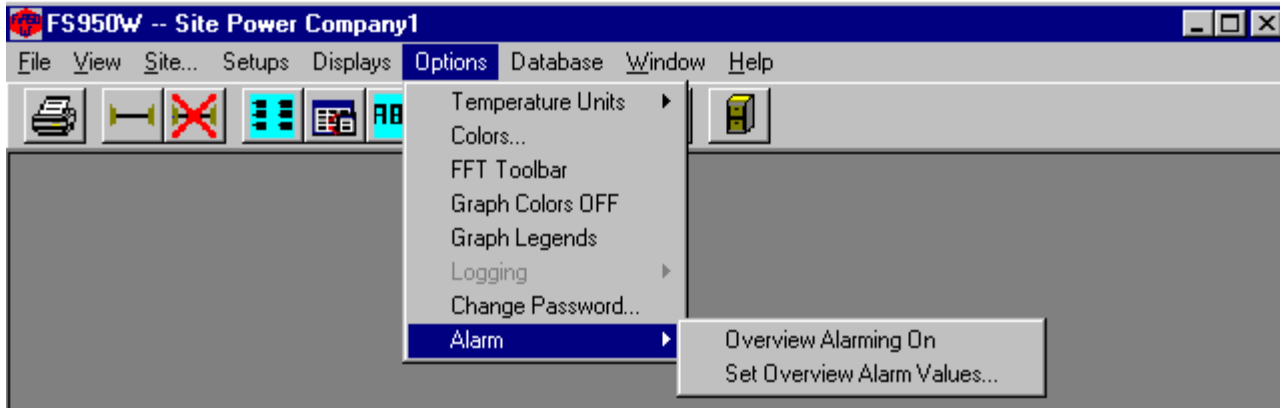

Overview Alarming On

The “Overview Alarming On” Item turns on the feature of logging the overview data whenever one of the parameters is outside the chosen limits. (See “Overview” screen section).

Set Overview Alarm Values

The “Set Overview Alarm Values” Item lets the user select upper and lower limits for the various parameters. If Alarming is On the data will be recorded to disk when these limits are exceeded. *The user must be running the “OVERVIEW” screen for this function to be active.* (See “Overview” screen section).

Database

The “Database” Items drops down to show “Open,” “Create” and “Delete.”

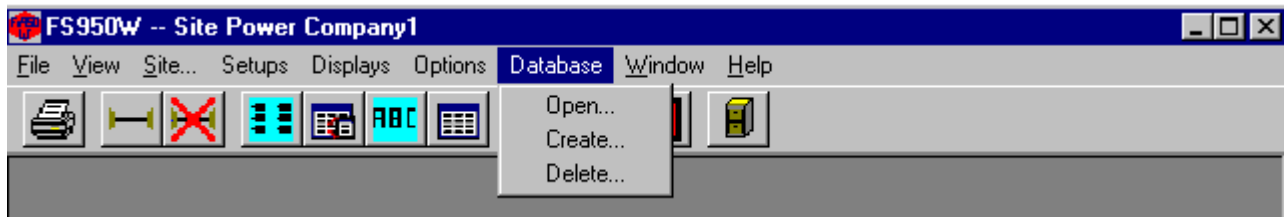

Open

“Open” allows the user to Select the database that will be used.

Create

“Create” allows the user to create a new database that can be used to contain all the units of a site.

Delete

The “Delete” Item allows the user to select a database to be deleted.

Note: When you select the database to be deleted, clicking on the “OPEN” button executes the delete command.

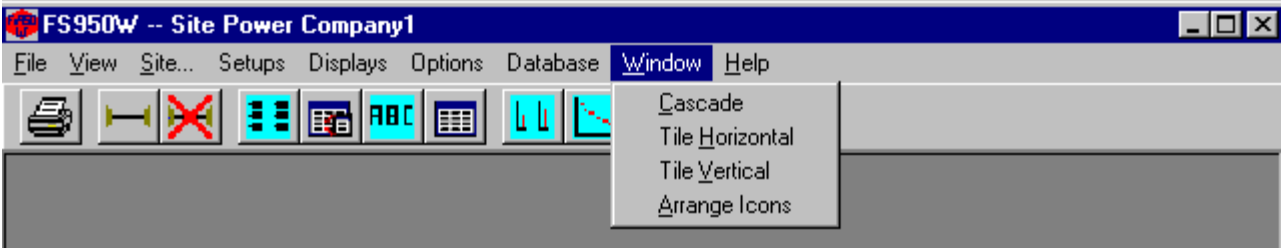

Window

The "Window" Item drops down to show "Cascade," "Tile Horizontal," "Tile Vertical" and "Arrange Icons."

Cascade

The "Cascade" Item shingles the dialog forms currently in use.

Tile Horizontal

The "Tile Horizontal" Item will first divide the screen horizontally with dialogs above and below each other.

Tile Vertical

The "Tile Vertical" Item will first divide the screen vertically with dialogs appearing beside each other.

Arrange Icons

The "Arrange Icons" Item will arrange the icons for any minimized dialogs at the bottom of the screen.

Help

The "Help" Item drops down to show "About FS950W."



About FS950W

"About FS950W" shows the Software version numbers and for non-NT operating systems it also can show the system information. It will display the user-entered "COMPANY NAME" and "SERIAL NUMBER."

FS950W TOOLBAR

The Toolbar buttons allow quick access to some of the Menu Items.

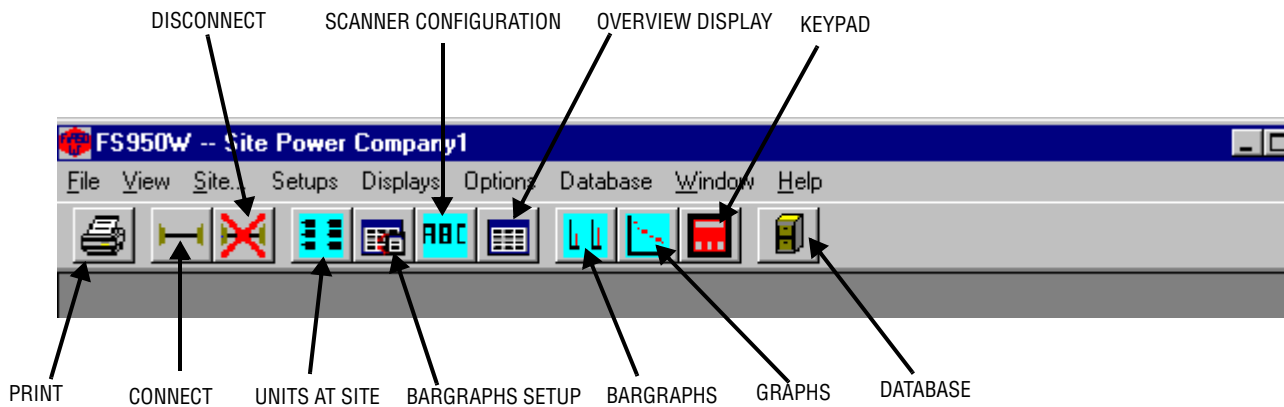

Print

“Print” will print the currently active screen.

Connect

“Connect” sets up and opens the serial port for communication with the scanners. If a Site was previously opened it will be closed along with all the open screens before the new Site is Opened.

Disconnect

“Disconnect” closes the serial port and closes any open screens.

Units at Site

“Units at Site” allows the setup and identification of all the scanners that are connected.

Bargraphs Setup

“Bargraph Setup” allows the selection and positioning of scanners on the bargraph screen.

Scanner Configuration

“Scanner Configuration” allows for the display, editing and saving of the internal scanner.

Overview Display

“Overview Display” shows the status and parameters for all scanners in the system.

Bargraphs

“Bargraphs Display” shows the Flame On/OFF bargraph screen.

Graphs

“Graphs” allows the user to view the FFT, Trend, and Time Graphs for the available scanners. Up to 4 graphs can be open at one time.

Keypad

“Keypad Display” allows for the remote programming of an individual scanner. Up to 12 keypads can be open at one time.

Database

“Database” allows the user to Select the database that will be used.

DATABASE



The FS950W uses an Access database to store program information. The registry maintains the current database identification so that the user does not have to select the database each time the program is started. A blank database is included with the installation kit and installed on the user's system. The database is located in C:\fireeye and is named FS950W.mdb. From the Database menu the user can select other databases to run and can create a new Empty database or Delete an existing Database.

SITE INFORMATION

The Site is the top-level control of the FS950W data. The Site contains the communications parameters and all records involving the Scanners are attached to a Site. **The Baud Rate should be 9600 with Parity set to None.** The port setting depends on the PC availability. For a Windows NT operating system check the NT System box to allow better communications. **The Description field is a required entry.**



Connect

Connecting to a Site opens and initializes the Comm Port, and loads in the Scanner records associated with the Site. If a Site is already connected it will be first disconnected and all screens closed.

Modify

The Modify allows the user to view any Site and make changes that can be saved. Modifying a Site will have no effect on the current operation until it is connected again.

Add

Allow the user to create a new site. The new site must be connected before it is used.



Disconnect

The Disconnect closes the port and also closes any open screens. The disconnect will also disable the Menu Items and buttons that require site information such as the displays and screen setups.

UNITS SETUP



The “Setup Units” screen is used to describe all the units that will communicate at the selected Site. This screen is a Modal screen, no other screens can be brought up until this one is closed.

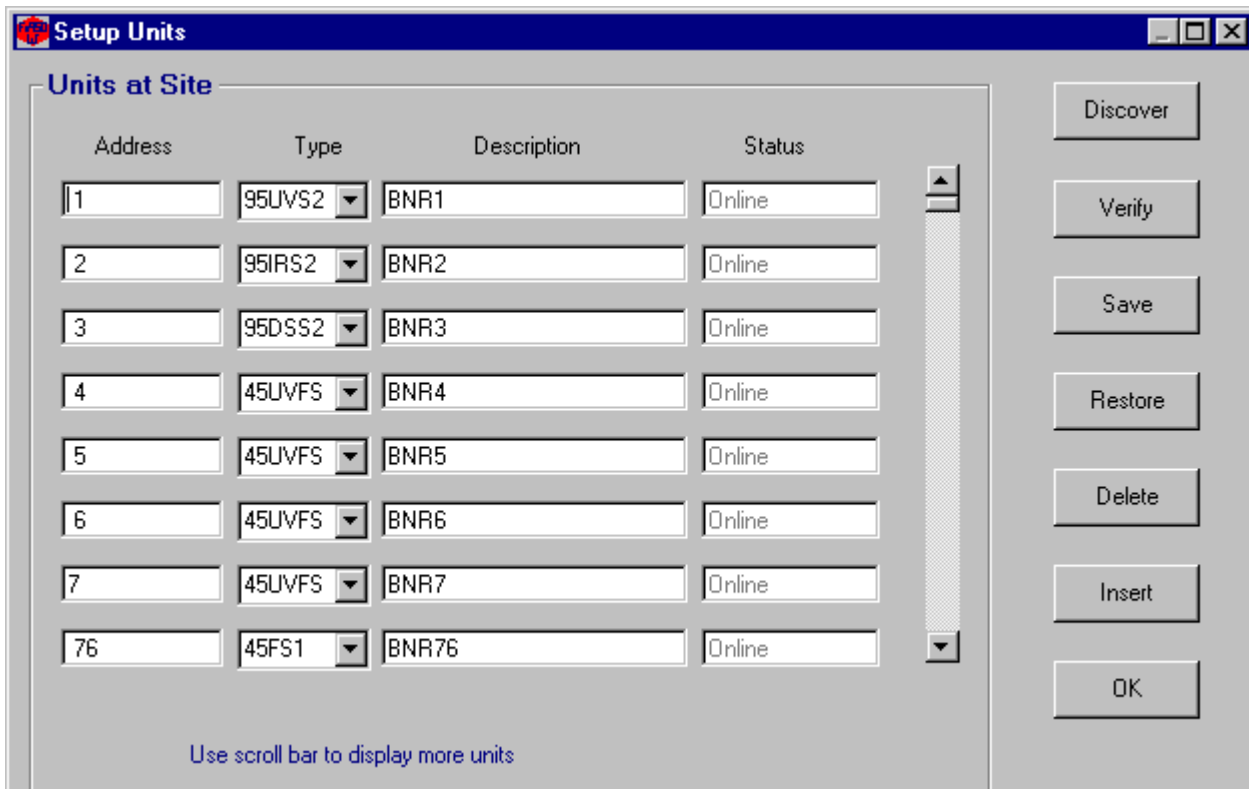

Setup Units

Units at Site

Address	Type	Description	Status
1	95UVS2	BNR1	Online
2	95IRS2	BNR2	Online
3	95DSS2	BNR3	Online
4	45UVFS	BNR4	Online
5	45UVFS	BNR5	Online
6	45UVFS	BNR6	Online
7	45UVFS	BNR7	Online
76	45FS1	BNR76	Online

Use scroll bar to display more units

Buttons: Discover, Verify, Save, Restore, Delete, Insert, OK

The fields on the “Setup Units” screen are saved in memory and in the database to maintain the essential information about the scanner units that are in use at this Site. The “Address” and “Description” are used throughout the program. In the “DESCRIPTION” column you would enter the burner “name” or location e.g. B1A (for burner 1, scanner A). The “Address” is the Modbus Address associated with a particular scanner. The “Address” can either be entered by the user or filled in by the “Discover” command button. The “Type” can be entered by the user or filled in by the “Verify” button. The “Description” is a user entered description or name for the particular scanner. The “Status” is returned by the “Discover” or “Verify” buttons.

Note: The Setup Units screen must be closed before you can open other screens.

Discover

The “Discover” button first clears the screen and then polls for all 128 addresses. Responses are added to the display with their “Address” and “Status.”

Verify

The “Verify” button checks all the listed units by sending the read EEPROM command. This function fills in the “Type” and “Status” for each “Address.”

Save

The “Save” button” writes the “Address,” “Type,” and “Description” to the database with its associated Site. The information is also maintained in memory when the screen is closed.

Note: The “Discover” and “Save” sequence should only be used when initially setting up the “Units” at Site”. If this sequence is used a second time, (e.g. using “Discover” to insert units that may not have initially been on-line, rather than using the “Insert” function), when Saved, all units may be duplicated on the list. If this occurs, however, the duplications can be removed via the “Delete” function.

Restore

The “Restore” button reads all the unit information for the selected Site from the database and then fills the Screen.

Delete

The “Delete” button removes the highlighted scanner from the database.

Insert

The “Insert” button will insert a new blank line between two addresses on the Units at Site screen. Place the cursor on the line *below* where you want the *new* line, then depress “Insert”.

OK

The “OK” button only saves the information in memory and any changes will be lost when the program is closed or the Site is changed. As long as the program is running, this information will be used throughout all the screens.

Cancel

The “Cancel” button can be used to stop the “Discover” and “Verify” processes. The “Discover” and “Verify” commands will leave the screen in the condition it was in at the point when “Cancel” was used.

FS950W BARGRAPHS SETUP



The “Bargraph Selection” screen is used to design and save the Bargraph Screens in the database.

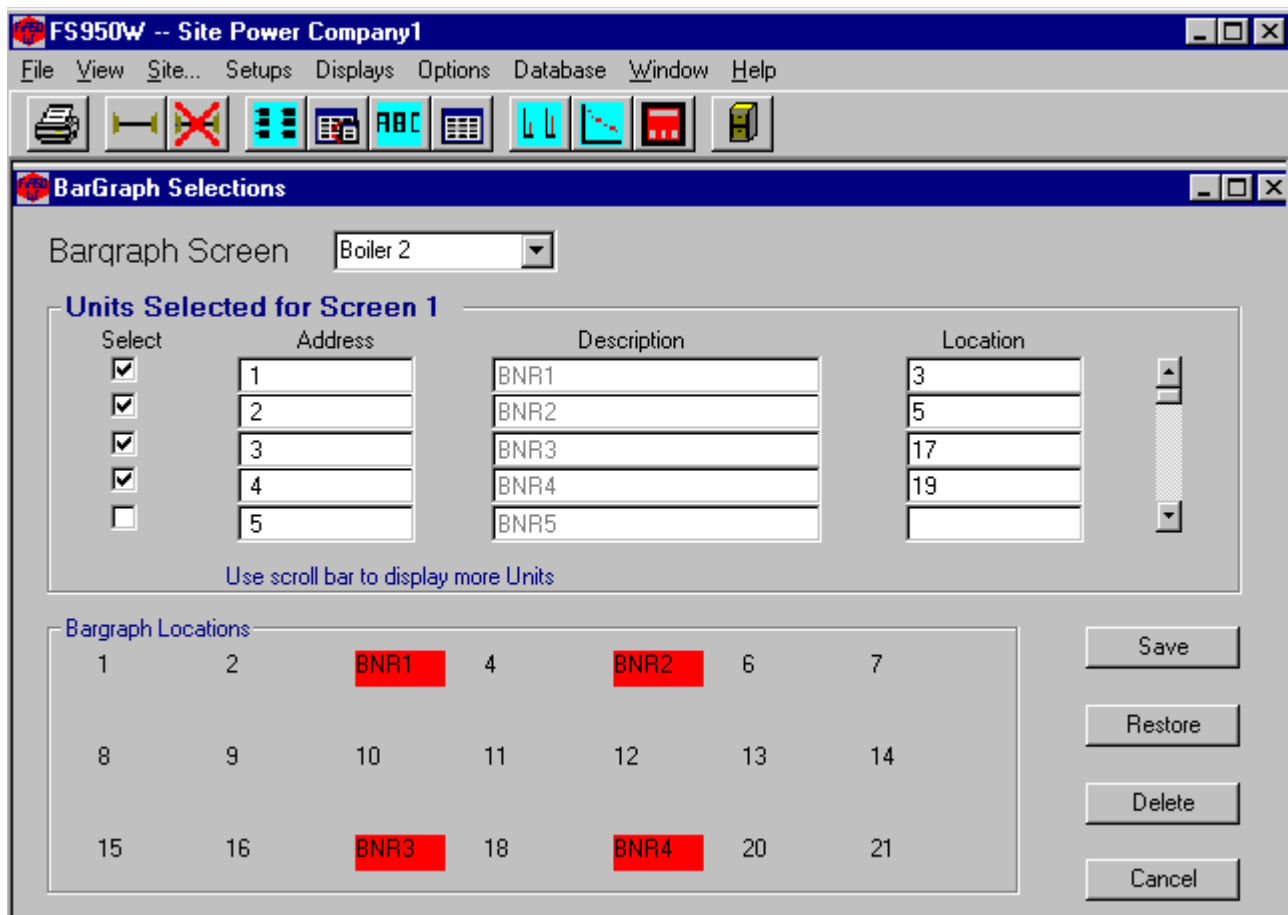

Units Selected for Screen 1

Select	Address	Description	Location
<input checked="" type="checkbox"/>	1	BNR1	3
<input checked="" type="checkbox"/>	2	BNR2	5
<input checked="" type="checkbox"/>	3	BNR3	17
<input checked="" type="checkbox"/>	4	BNR4	19
<input type="checkbox"/>	5	BNR5	

Use scroll bar to display more Units

Bargraph Locations

1	2	BNR1	4	BNR2	6	7
8	9	10	11	12	13	14
15	16	BNR3	18	BNR4	20	21

Buttons: Save, Restore, Delete, Cancel

The “Bargraph Selections” Screen shows all the scanners at the site as defined with the “Setup Units” screen. The Combo box at the top of the selection screen contains the currently defined “Bargraph Screens”. The user can select an existing screen to edit or begin with a new screen. Once the

“Location” for a bargraph is entered (see “Location layout” at bottom of the selection screen) the “Select” box can be checked. A highlighted position will appear on the “Bargraph Locations” window at the bottom of the selection screen. **As an alternative method, the scanner “Address” can be dragged down and dropped on the desired position.** To remove a bargraph from a “Bargraph Screen” just uncheck the “Select” box. The Bargraphs of scanners placed directly beside each other (such as positions 4 and 5) will overlap each other on the screen.

The “Bargraph Selection” screen depends on the available scanners being stored in the backing array for scanner units. The backing array for scanner units is filled by the “Setup Units” screen. All scanners entered in the Units screen will appear in the scrolling section at the top of the screen.

Note: When creating a name for a bargraph screen, you should limit the name to 10 characters or less. A longer name will not be accepted and will result in an error message.

Save

The “Save” button must be used to save the “Bargraph Screen” to the database before it can be used. The “Bargraph Screen” information is not maintained in memory. A screen name can only be used once for each site. A duplicate name will overwrite the original when it is saved.

Restore

The “Restore” button is used to read in the selected “Bargraph Screen” information from the database. The screen will be cleared and the selection will be displayed again effectively removing any unsaved changes that have been made.

Delete

The Delete” button will remove the currently displayed “Bargraph Screen” from the database.

Cancel

The Cancel closes the screen without saving anything.

PRINT FUNCTION



The print function will send a screen shot of the currently active screen to the printer.

SCANNER CONFIGURATION SCREEN



The “Scanner Configurations” screen allows for the viewing, editing and saving of the internal Scanner files.

SIGNATURE SCANNER CONFIGURATION

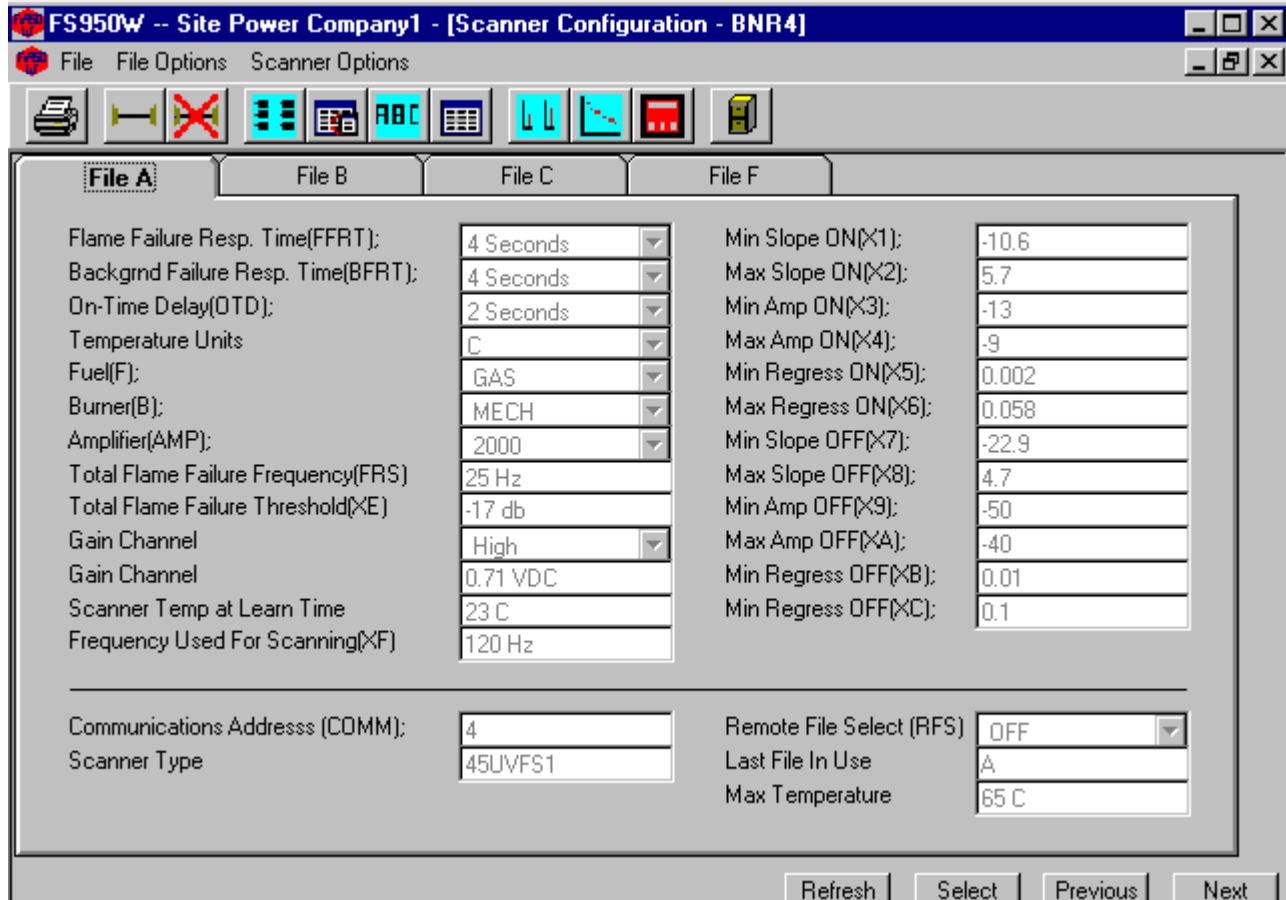

Parameter	Value	Parameter	Value
Flame Failure Resp. Time(FFRT);	4 Seconds	Min Slope ON(X1);	-10.6
Backgrnd Failure Resp. Time(BFRT);	4 Seconds	Max Slope ON(X2);	5.7
On-Time Delay(OTD);	2 Seconds	Min Amp ON(X3);	-13
Temperature Units	C	Max Amp ON(X4);	-9
Fuel(F);	GAS	Min Regress ON(X5);	0.002
Burner(B);	MECH	Max Regress ON(X6);	0.058
Amplifier(AMP);	2000	Min Slope OFF(X7);	-22.9
Total Flame Failure Frequency(FRS)	25 Hz	Max Slope OFF(X8);	4.7
Total Flame Failure Threshold(XE)	-17 db	Min Amp OFF(X9);	-50
Gain Channel	High	Max Amp OFF(XA);	-40
Gain Channel	0.71 VDC	Min Regress OFF(XB);	0.01
Scanner Temp at Learn Time	23 C	Min Regress OFF(XC);	0.1
Frequency Used For Scanning(XF)	120 Hz		
<hr/>			
Communications Address (COMM);	4	Remote File Select (RFS)	OFF
Scanner Type	45UVFS1	Last File In Use	A
		Max Temperature	65 C

The Scanner Configuration shows the contents of the memory files of the current Scanner. The “Previous” and “Next” buttons cycle through all the available scanners as defined on the “Unit Setup” screen. The “Select” button allows the user to select the scanner from a list of all scanners available at the site. The fields appearing below the line are the same for the A, B and C files. The “Refresh” button updates the screen (re-reads the data from the scanner).



INSIGHT SCANNER CONFIGURATION (Model DS)

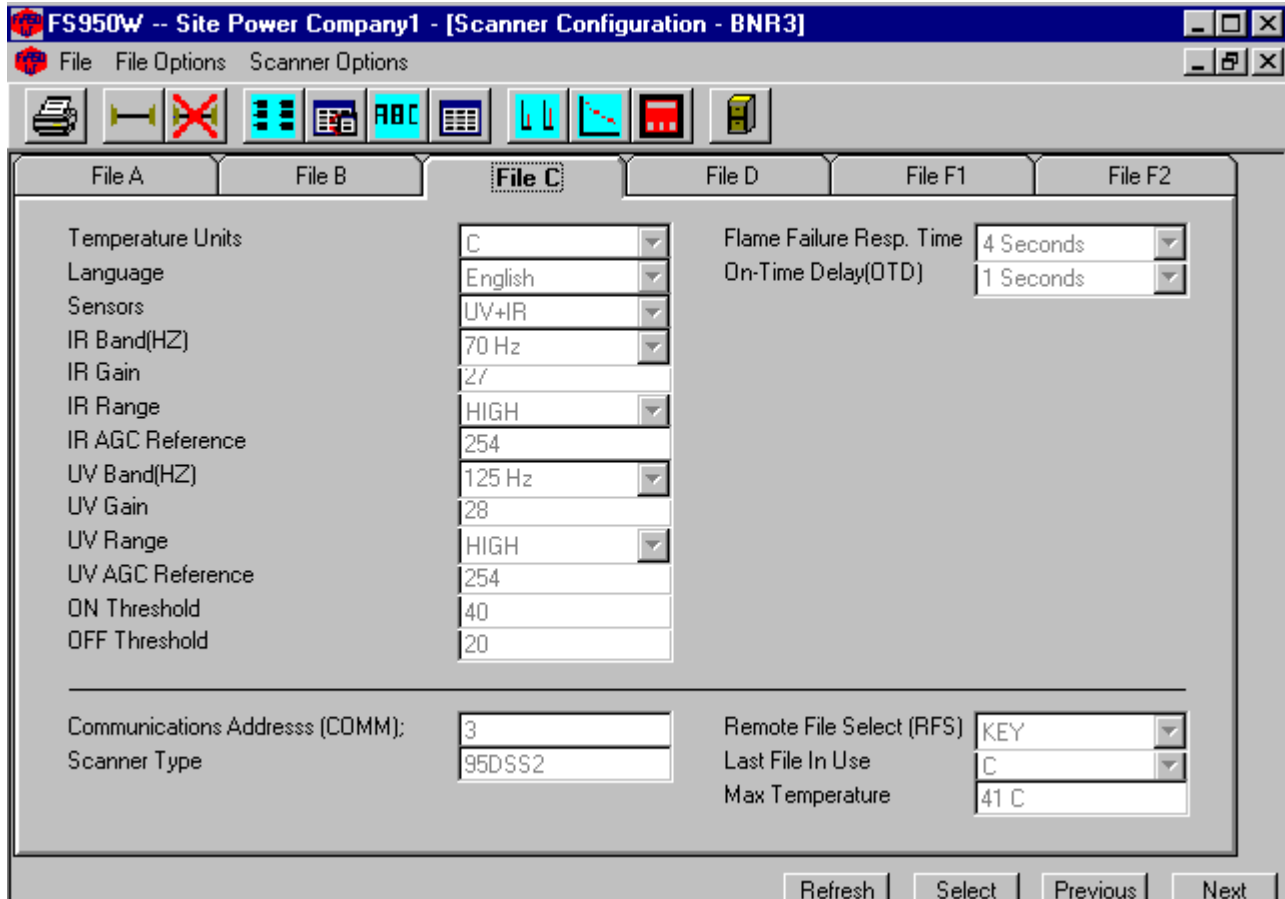

Menus

The Menu at the top of the Scanner Configuration Screen contains several Items that activate scanner functions. The Items “File,” “File Options,” and “Scanner Options” all drop down.

FILE

The “File” Item drops down to show “Print,” “Enable Flame Data” and “Enable Configuration Edit.”

Print

The print function will send a screen shot of the currently active screen to the printer.

Enable Flame Data

(For Fireeye Factory use only).

Enable Configuration Edit (Signature Scanners only)

When enabled, the user may edit the scanner configuration *on the configuration screen*, and then download the new configuration to the scanner. This option is an alternative to using the *keypad screen* to change scanner configuration.

Note: To save and download scanner files, refer to “Instructions” at the end of this section.

FILE OPTIONS

The “File Options” Item drops down to show “Default Settings,” “Load From File” and “Save to File.”

Default Settings

“Default Settings” will drop down to show “Set F to Factory” and “Copy F to All.”

Set F to Factory

This option set the File F tab page values to the standard factory settings.

Copy F to All (Signature Scanners only)

This Option allows the user to copy the values on the File F tab page to the A, B, and C pages also. This allows for an initial setting of all the data.

Load From File

The Load From File option allows the user fill the A, B, and C pages with data from previously saved configuration file. A Dialog screen allows the user to set the path and file name of an ASCII file.

SCANNER OPTIONS

The Save to File Option allows the user to save the current A, B, and C File pages to an ASCII file for future use. A Dialog screen allows the user to select the path and file name for saving the file. This option requires the user's Password.

Scanner Options

The "Scanner Options" Item drops down to show "Read Data from Scanner," "Download To Scanner" and "Download to All Scanners."

Read Data From Scanner

The Read Data From Scanner Option reads the EEPROM data from the current scanner and displays the values in the A, B, and C File Pages (refreshing the screen).



CAUTION: Downloading to the scanner will cause it to reset. Scanner Configuration data is learned for each scanner and each scanner requires different parameter values to operate correctly. Do not download values from one different scanner to another.

Download To Scanner (Signature Scanners only)

The Download To Scanner Option writes the current values on the A, B, and C File Pages to the current Signature Scanner. This Option requires the use of the User Password.

Download to All Scanners (Signature Scanners only)

The Download to All Scanners Option copies the values displayed on the A, B, and C File pages to all of the Signature Scanners at the Site. This Option requires the use of the User Password.



CAUTION: This action will cause all of the scanners to reset. Scanner Configuration data is learned for each scanner and each scanner requires different parameter values to operate correctly. Do not download values from one scanner to another as this will cause improper functioning. This function should only be used during initial setup and requires that each scanner perform the learn flame function after the download occurs. This allows the common values (e.g. Fuel Type, Amplifier Type, FFRT, etc.) to be preloaded in the scanner.

INSTRUCTIONS TO LOAD AND SAVE FILES

SAVING a scanner configuration file (Reading from the scanner, saving to a computer file).

1. Select and display the scanner configuration you wish to save.
2. Click on **FILE OPTIONS, SAVE TO FILE.**
3. You will be prompted to enter a password.
4. The software will prompt you to enter a file name with the extension “.FS1”.

LOADING a stored configuration file to a new scanner (Reading from the computer file, downloading to the scanner). Signature Scanners only.

1. Select and display the scanner configuration of the NEW scanner.
2. Click on **FILE OPTIONS, LOAD FROM FILE.**
3. Select the stored configuration file that you wish to send to the new scanner.
4. The stored configuration data file will now be displayed on the screen.
5. Click on **SCANNER OPTIONS, DOWNLOAD TO SCANNER.**
6. You will be asked to verify that you wish to continue, and will be prompted to enter a password.

FS950W OVERVIEW SCREEN



The “Overview Screen” is used to monitor the status of all the scanner units at the site.

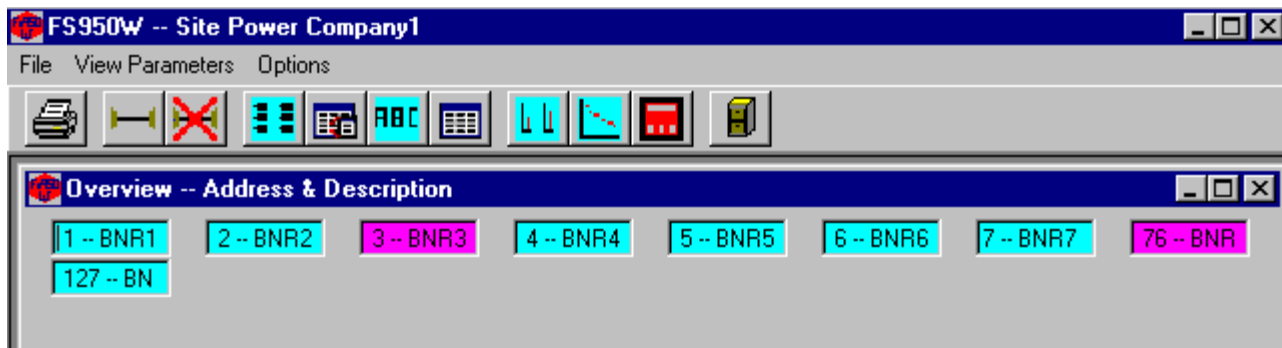

The “Overview” screen initially shows all of the scanners by Address and name. Those that have reported a “FLAME_ON” condition are shown in the FLAME-ON color as defined under Menu Item Options” – “Colors” – “Text Highlight” while those reporting a “FLAME_OFF” are shown in the color that was chosen for the OFF condition. There is a separate Color for any unit with which there was a communications error. Any units that are above their max temp will blink.

View Parameters

The “View Parameters” menu item allows one of the available parameters to be shown along with the Modbus address in the textboxes. Other parameters in addition to the description are; Flame Quality, Flame Intensity, Temperature and Loaded File. With a Signature Scanner, the following additional parameters may be viewed: Flame Intensity, Slope, Amplitude and Regression. The Caption line for the Overview screen gives the names of the parameters that are being shown.

Options

The “Options” menu item has the drop down items of; “Temperature Units,” “Logging” and “Alarm.”

Temperature Units

The “Temperature Units” sub-item allows the user to choose either Fahrenheit or Centigrade for displayed temperatures.

FROM THE OVERVIEW SCREEN YOU MAY:

Continuously log (record) the “Flame Quality” and “Flame Intensity” of all scanners on the overview screen. This data log cannot be viewed through the FS950W software, but is instead sent to a file and destination that you create. The data is in a spreadsheet (comma delimited) format. (Refer to EXCEL note at the end of this section.)

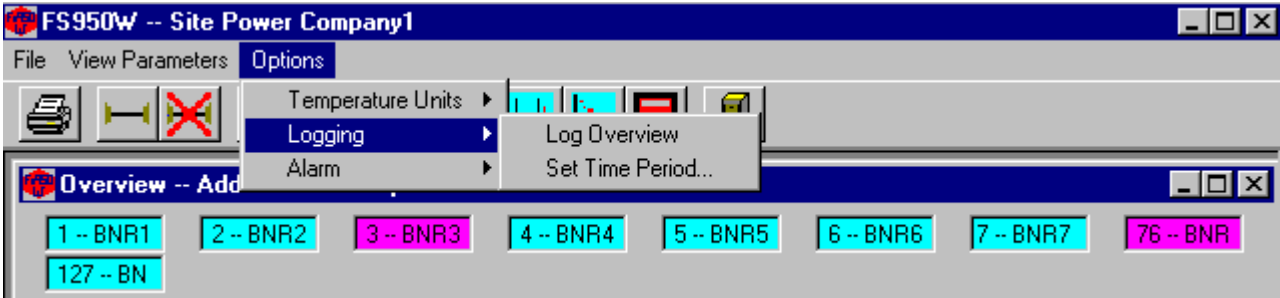

To activate **OVERVIEW LOGGING**:

Click on: **OPTIONS, Logging**

Select: **Log Overview**

You will be prompted to enter and save a file name. The default file name is “Todays.Log”.

Note: If you have activated the overview logging, and the overview screen is open, at 12:00 mid-night, the data from “Todays.Log” will automatically be transferred to a new file titled “Yesterdays.Log”, and “Todays.Log” will start afresh. If the overview logging continues for another day, a third file will automatically be created, titled “DayBeforeYesterdays.Log”.

You may set the time period (interval) of the data update rate for the logging file:

Click on: **OPTIONS, Logging, Set Time Period**

From the Logging Period pull-down menu, you may select from interval times ranging from 5 seconds, to 1 hour. There is also a choice named “All Data” which will select a continuous update (an update every time the scanner is polled on the overview screen).

Note: Regardless of the Logging Time Period selected, the effective update rate can be no faster than the actual scanning rate as observed on the overview screen. The overview scanning rate is a function of the quantity of scanners displayed, and may be several seconds long.

To view the overview log (e.g. Todays.Log), you must access the file through Windows.

FROM THE OVERVIEW SCREEN YOU MAY:

Log scanner data triggered by user selectable ALARM VALUES. This feature allows the user to create a log file where scanner data is updated only when it exceeds user selected minimum or maximum values. Once the alarm limit(s) is selected, an alarm log will occur if this limit is exceeded by any scanner on the overview screen. This data log cannot be viewed through the FS950W software, but is instead sent to a file and destination that you create. The data is in a spreadsheet (comma delimited) format. (Refer to EXCEL note at the end of this section.)

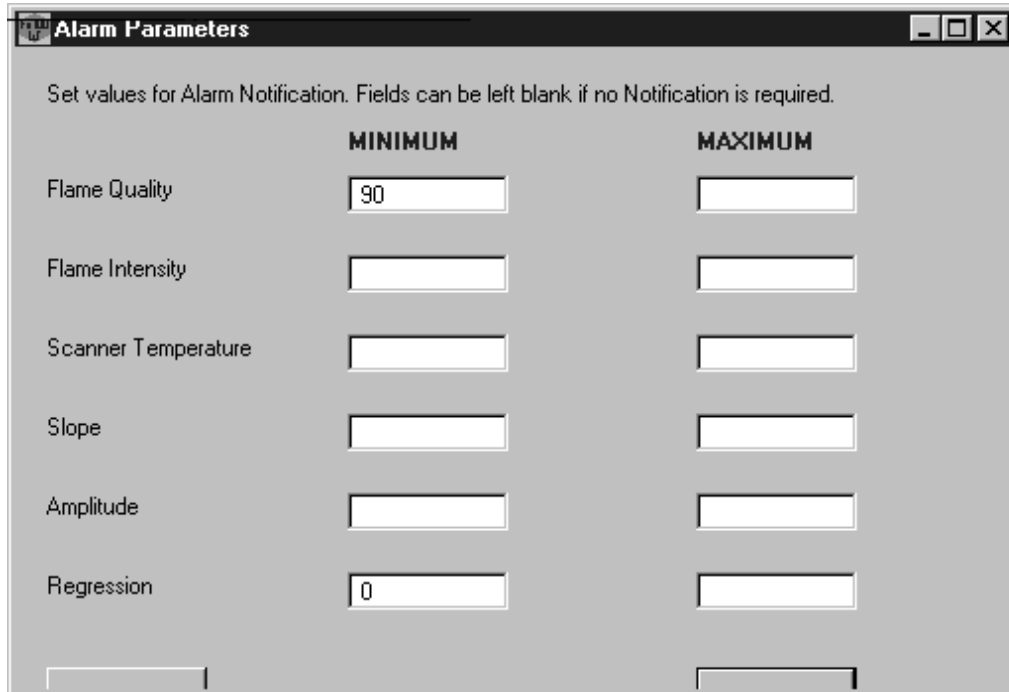

	MINIMUM	MAXIMUM
Flame Quality	90	
Flame Intensity		
Scanner Temperature		
Slope		
Amplitude		
Regression	0	

To Activate **ALARM**:

Click on: **OPTIONS, Alarm, Alarm ON**

You will be prompted to enter and save a file name. The default file name is “OverviewAlarm.Log”.

To select Alarm setpoints:

Click on: **OPTIONS, Alarm, Set Alarm Values**

You are then allowed to set one or several parameters that will trigger an entry into the Overview Alarm.log file. Choices include: Flame Quality, Flame Intensity, Temperature, Slope, Amplitude, Regression.

To view the Alarm log (e.g. OverviewAlarm.Log), you must access the file through Windows.

EXCEL Note:

The following describes copying the OVERVIEW and ALARM logs to EXCEL:

In EXCEL, open the desired file (e.g. OverviewAlarm.log).

The “Text Import Wizard” will appear.

Step 1: Chose “Delimited”

Click on “next”

Step 2: Select “Comma” delimited

Click on “next”

Step 3: In data preview, highlight the Date/Time section

In column format section, click on “Date” (MDY)

The log file will now open in EXCEL. Increase column width as required.

Clicking

By “Clicking” the left mouse button over a selected scanner the user can bring up a list of all the available parameters and their values for that scanner. The values in the popup list will change as that particular scanner is updated. “Double Clicking” on a particular textbox allows the user to select from the “Graphing,” the “Keypad “or the “Scanner Configuration” screen for that scanner.

KEYPAD/DISPLAY SCREEN



The “Keypad” Screen duplicates the action of the scanner keypad display.

SIGNATURE SCANNER KEYPAD

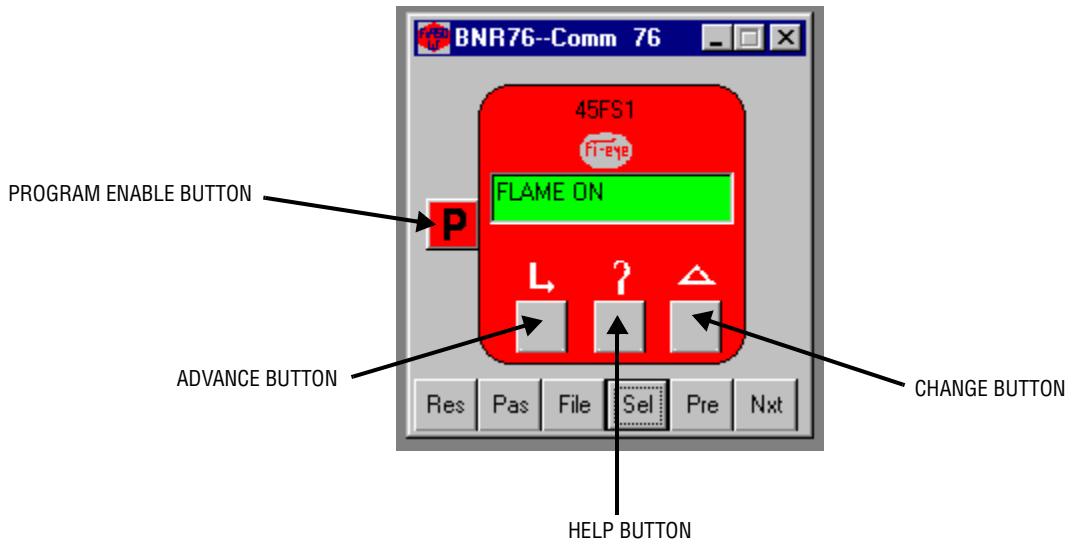

Keypad Buttons

The Keypad Buttons duplicate the actions of the buttons on the scanner itself. The Signature Scanner buttons are the Advance, Help, Change, and Program Enable. These buttons are used to program the Signature Scanner and their operation is described in bulletin CU-33. The InSight Scanner buttons are Up, Down, Select and Program. These buttons are used to program the InSight scanner and their operation is described in bulletin CU-95.

Screen Buttons

There are up to 6 buttons on the screen itself which are used with the keypad. With a Signature Scanner these buttons are Res (reset), PAS (password), File, Sel (select), Pre(previous), and Nxt (next).

With an InSight scanner, these buttons are: File, Sel (select), Pre(previous), and Nxt (next)

Next and Previous

The “Next” and “Previous” buttons change the scanner being viewed. These buttons will cycle through all the scanners listed in the “Unit Setup”.

Select

The Select button allows the user to select a specific scanner without stepping through all those that may be available. The user can either enter the Comm Address or select the unit by description from the available list.

Password (Signature Scanners only)

The “Password” button allows the password to be set or canceled depending upon its current state. The password remains active for 10 Minutes and applies to all “Keypads” that were in use at the time the password was invoked. If the password is not entered using the “Pass” key the program will ask for it when the “Program” button is pressed. The procedure for programming the scanner using this screen is the same as from the scanner’s own keypad. **The factory preset is “fireye”.**

File (Signature Scanners only)

The File button allows the user to select the internal file that is to be run for this current scanner. The scanner's "Remote File Select" parameter must be set to "COMM" for this command to have any effect.

Reset (Signature Scanners only)

The "Reset" button reboots the scanner's microprocessor, momentarily turning it off. **If the burner is operating, it will trip.** The software will prompt you to enter the password because of this action.

Display

By passing the cursor over the various buttons on the screen the descriptions can be seen in the small tool tip windows. The contents of the text window can also be viewed in one of the tool tip windows. The text in the Window will scroll if it is too long to appear all at one. The tool tip box will show the entire text without scrolling.

***NOTE:** Because of their high communications use, the keypad screen may severely slow down any other screens such as the overview screen and the graphs. The keypads should be used by themselves to prevent conflicts.*

INSIGHT SCANNER KEYPAD

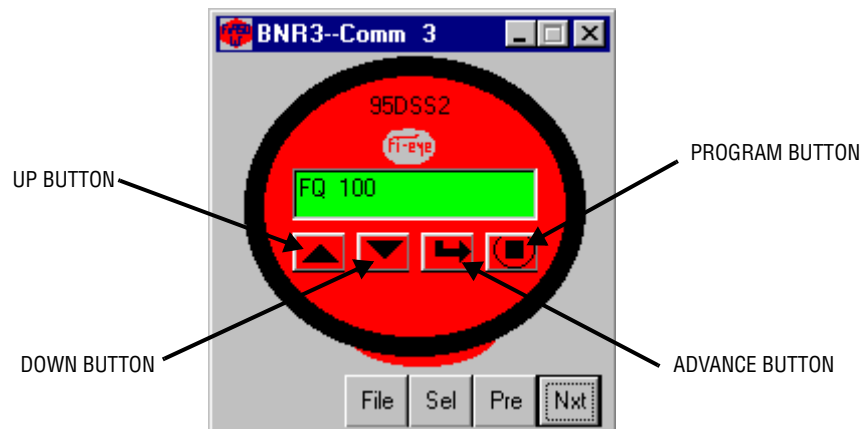

BARGRAPH SCREEN



The Bargraphs Screen depicts the Flame Quality and FLAME-ON/FLAME-OFF parameters as a bargraph for each scanner.

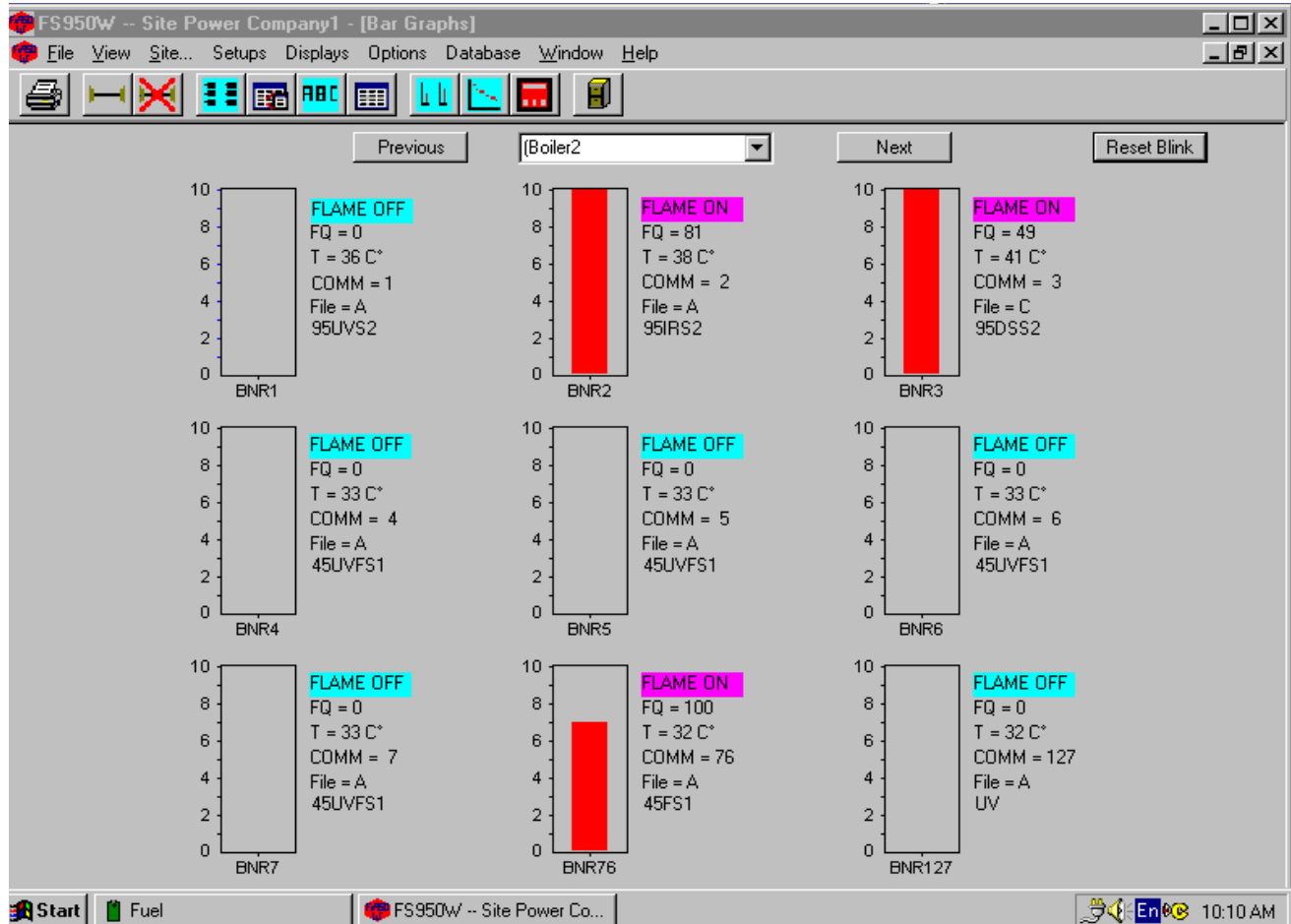

The Flame Quality is depicted as a value from 0 to 100. The scanner description, current file, Current Temperature and Comm Address are also shown.

Note: If Bargraphs are located on the bottom row of the screen, their burner identification will be obscured until you maximize the Bargraph Screen.

FROM THE BARGRAPH SCREEN YOU MAY:

LOG (RECORD) SCANNER DATA

This feature allows the user to capture scanner data (Flame quality, amplitude, etc.) at the time of, and immediately before a Flame OFF condition. This information may be of value in determining the cause of a burner flame out. This feature is active only while the bargraph screen is running.

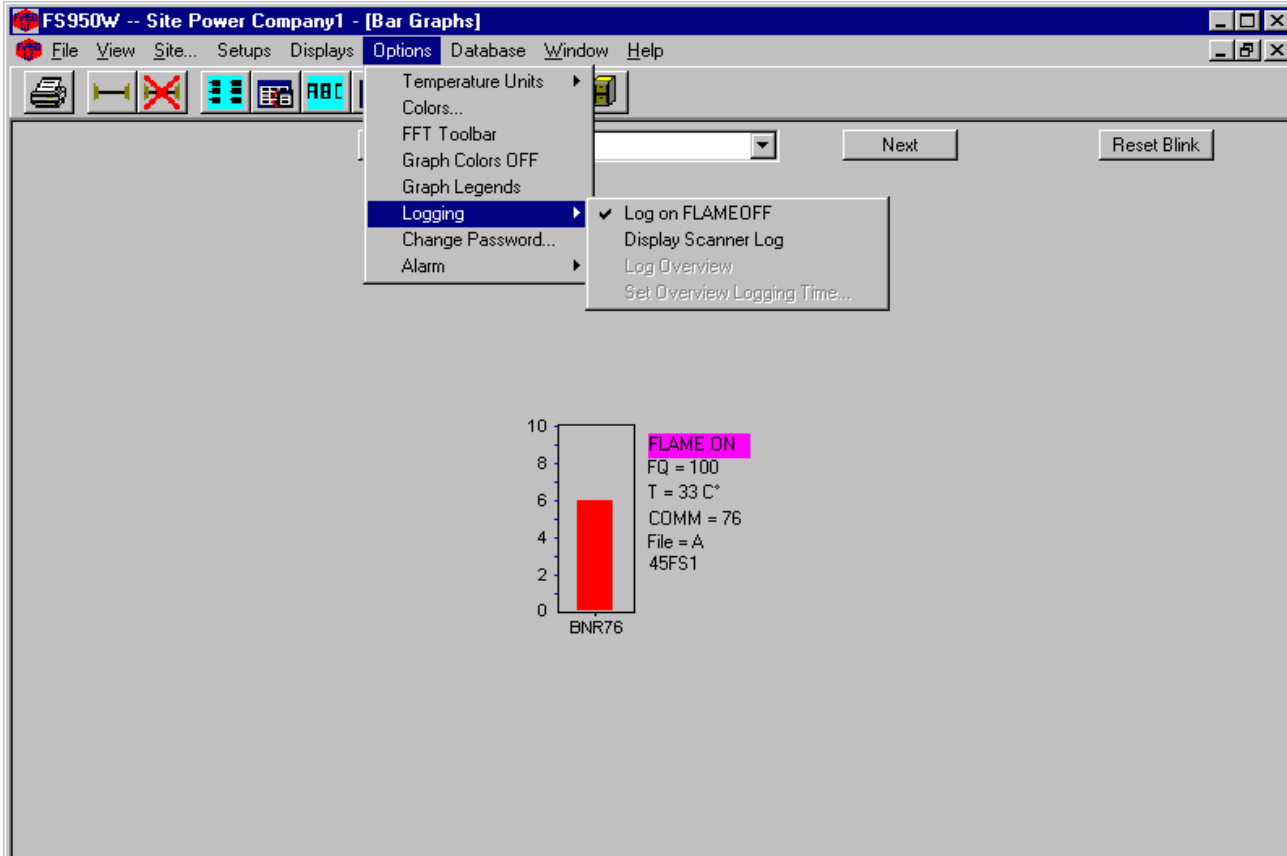

To activate **BARGRAPH LOGGING**:

Click on: **OPTIONS, Logging**

Select: **Log on FLAMEOFF**

You will be prompted to enter and save a file name. e.g. “Boiler1”. The software will automatically assign a “.log” extension.

With “Log on FLAMEOFF” selected, any time a scanner (on an open bargraph screen) displays “Flame OFF” a log file will automatically be created. The new file name will be the file name you previously created, (“Boiler1” in the above example), with an extension showing the scanner’s communication address, e.g. “Boiler1.log12” for scanner address 12.

To view the log:

Click on: **OPTIONS, Logging**

Select: **Display Scanner Log**

You will be prompted to select and open a log file, e.g. “Boiler1.log12”. The log file will contain the scanner’s operating parameters (Flame ON/OFF status, Amplitude*, Slope*, Regression*, Intensity (individual bargraph height), Flame Quality, and Temperature). These parameters will be displayed in eleven rows, showing their values *at the time the scanner first displayed “Flame OFF”*, plus their values *at the nine updates immediately previous to Flame OFF*, and *one update immediately after Flame OFF*. The parameters marked (*) apply to Signature Scanners only.

Note: Due to the scan rate, the value of “Intensity” in a log file may not display “0” when flame is OFF. This is normal.

The data contained in these files will be over-written the next time the scanner goes from Flame ON to Flame OFF.

GRAPH SCREENS



The Graph Window allows the user to view the scanner information as an FFT Graph, a Trend graph, or a Time Series Graph.

FFT GRAPH

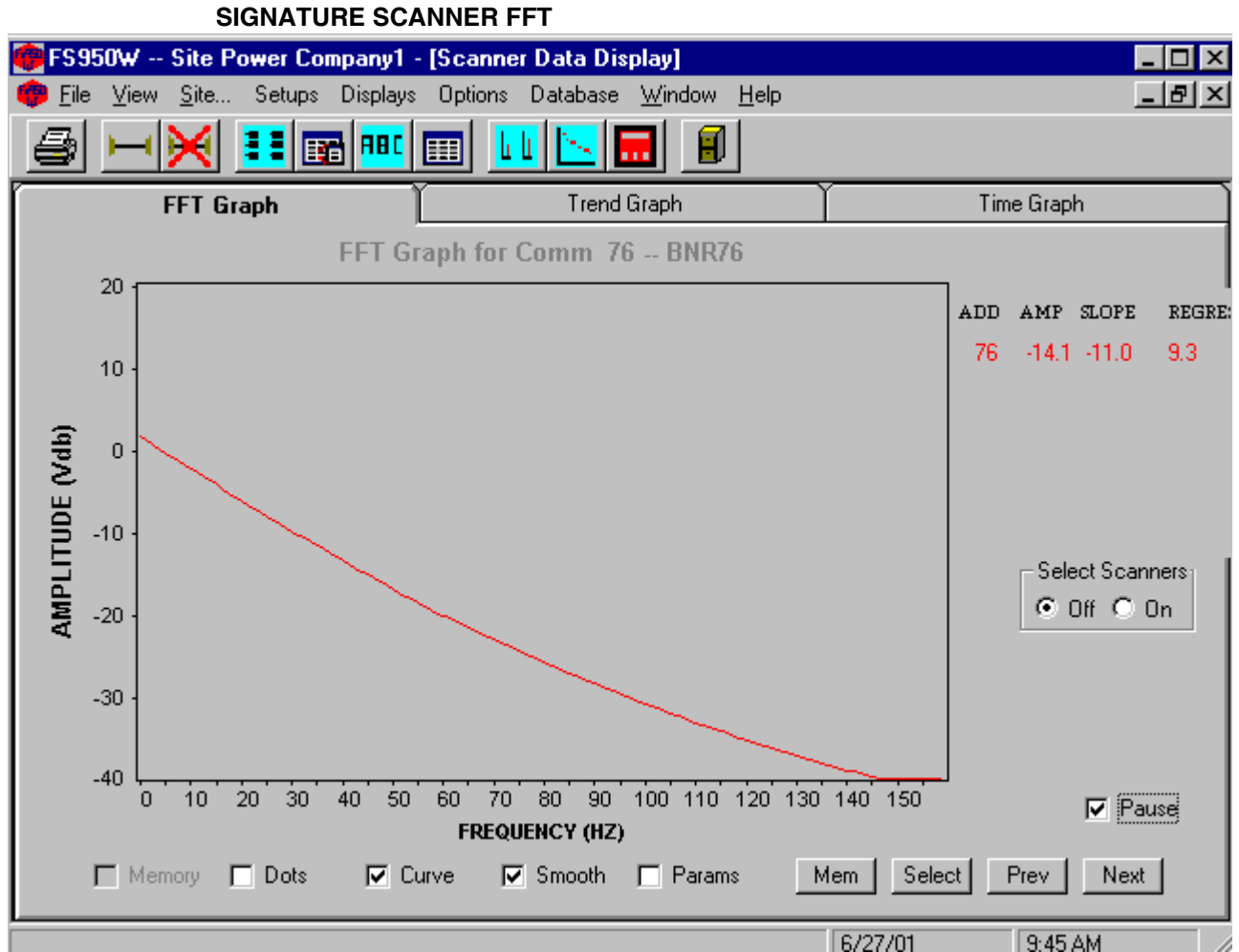

The Signature Scanner uses a 256 point Fast Fourier Transform to analyze the data from the target flame. The FFT screen contains the graphic representation of those points.

Dots

The “Dots” checkbox, when selected, presents the raw data as individual dots.

Smooth (Signature Scanner FFT only)

Smoothing must be used before the curved line can be used on the graph. When the “Smooth” checkbox is checked, the scanner filters the data before sending it to the FS950W software. This smoothing more closely approximates a line.

Curve (Signature Scanner FFT only)

When the “Curve” checkbox is selected the software will represent the points as a curved line using a linear approximation with a “least squares fit” calculation. The line shown is actually made up of two lines generated by the quadratic equation $ax^2 + bx + c$ which determine the least squares fit on the data. One set of co-efficients (aq^1 , bq^1 and cq^1) determine the least squares fit on the data points from 0 Hz to 60 Hz. The other set of co-efficients (aq , bq , and cq) determine the least squares fit



based on the data points from 50Hz to 150 Hz. These co-efficients can be displayed by checking the Parameters checkbox. Only the Curve representation can be used when multiple scanners are being displayed.

Parameters (Signature Scanner FFT only)

Checking Params displays the co-efficients used to calculate the curved line representation of the FFT. When the Params is unchecked the Amplitude, Slope, and Regression parameters are shown for the particular scanner. When multiple scanners are graphed on the same display the parameters are shown in the color of the graph line.

Amplitude (Signature Scanner FFT only)

The Amplitude represents the strength of the flame signal at the frequency that offers the greatest discrimination. The scanner chooses this frequency during the “Learn Flame On” and “Learn Flame Off” procedures. This frequency can be seen in the Scanner Configuration Files beside the title of “Frequency Used for Scanning (XF)”.

Slope (Signature Scanner FFT only)

The Slope represents the difference between the slope lines of the data at a low and high flame flicker frequency e.g. 20 Hz and 80 Hz. When the flame is on the delta slope should be close to zero. With a Flame Off condition the delta slope should increase significantly (e.g. to -40).

Regression (Signature Scanner FFT only)

Linear Regression represents how close the data points resemble a straight line. With a “Flame On” condition, the data should be approximately a straight line, so the linear regression should be a low number. With “Flame Off” the linear regression should increase significantly (e.g. 150 – 300).

Memory

The Memory **checkbox** will toggle the display of the memorized data if a curve has been memorized. The Memory **button** can be pushed to memorize the curve data at any point. If there are multiple scanners being graphed the last one updated will be the one memorized. There can only be 6 lines on a graph. If there are 6 scanners being displayed the show memorized data will not show anything and one of the scanners will have to be removed from the display in order to show the memorized data.

Select Scanners

The Select Scanners box allows the user to make visible the list of scanners that can be selected for the graph display. Setting the Off radio button removes the list but does not change the display. Scanners are added or removed from the display by checking or unchecking the list item. Up to 6 scanners can be selected for simultaneous display, see example on following page.

Next and Previous

The “Next” and “Previous” buttons change the scanner being viewed. These buttons will cycle through all the scanners listed in the “Unit Setup”. Next and previous will start their search based on the scanner as listed in the Graph title line. Adding or changing scanners by using the select scanners list box will not change the initial scanner shown in the title.

SIGNATURE SCANNER FFT (Two scanners being viewed)

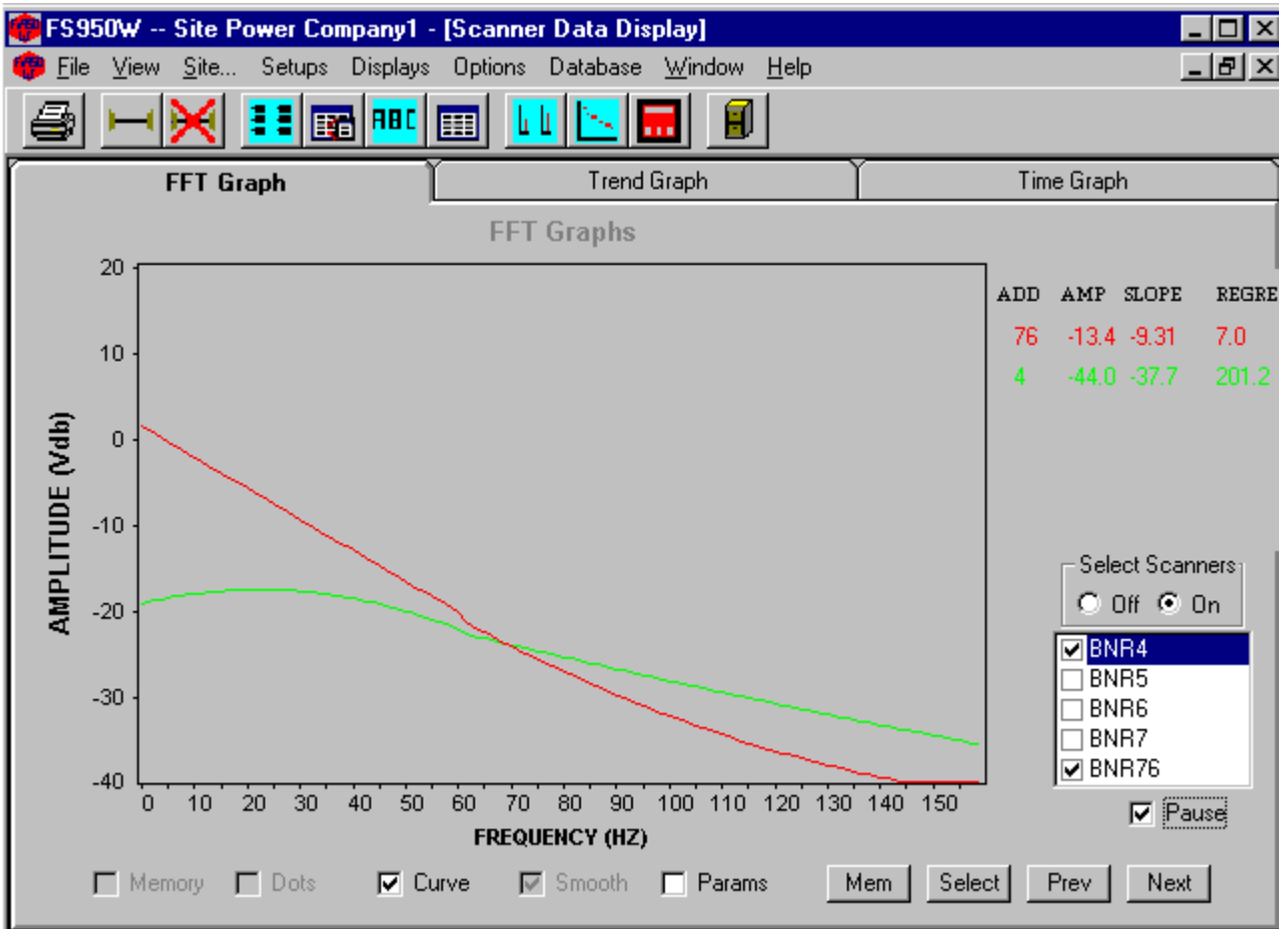

INSIGHT SCANNER FFT (DS Model shown)

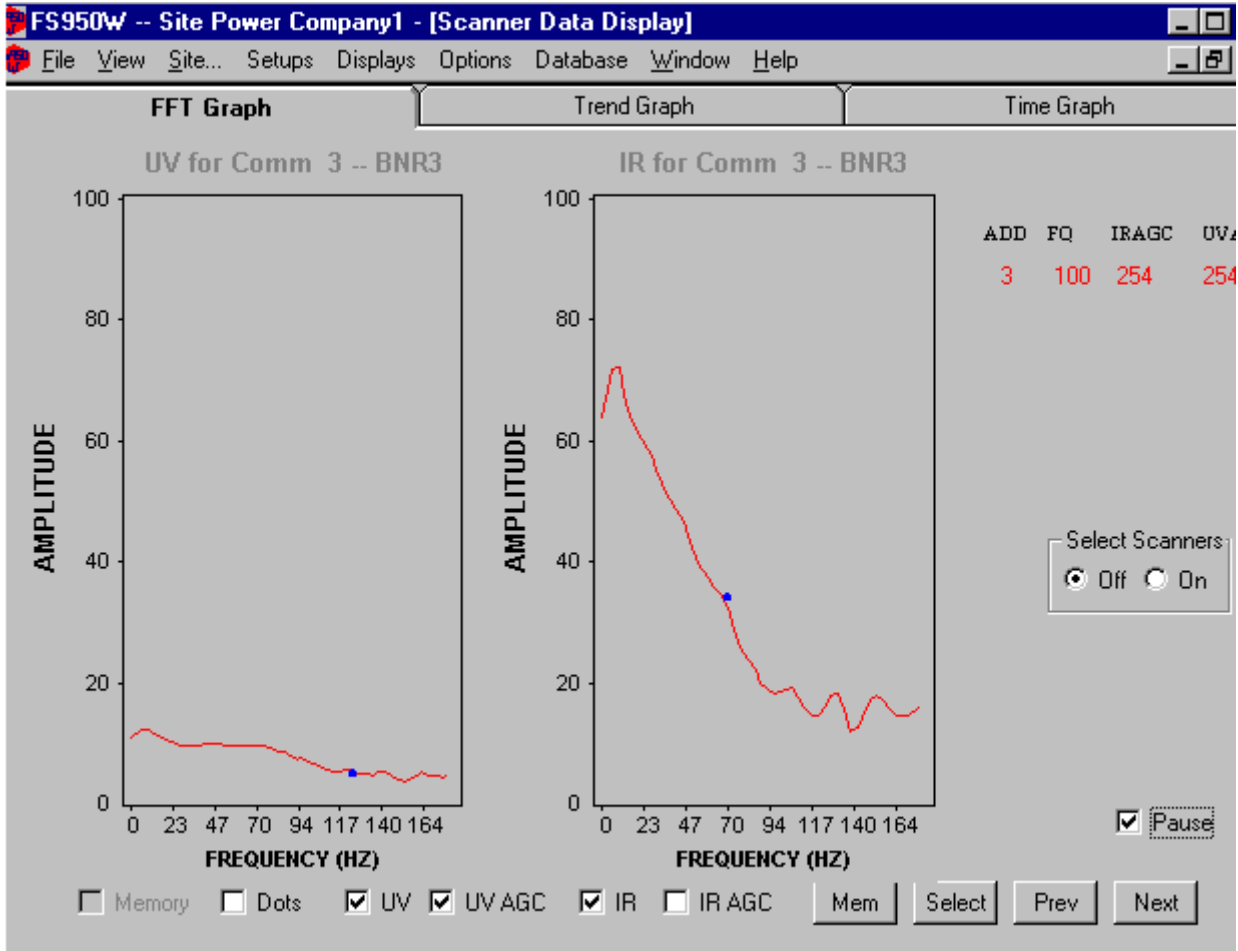

Note: In the above figure, the “dot” on the UV FFT curve indicates that a target frequency of 117 Hz. has been programmed into the InSight scanner for the ultraviolet sensor. The “dot” on the IR FFT curve indicates that a target frequency of 70 Hz. has been programmed into the InSight scanner for the infrared sensor.

UV (InSight scanner only)

Checking “UV” will show the FFT curve for the ultraviolet sensor (if applicable)

UV AGC Check Box (InSight scanner only)

Checking “UV AGC” will reduce the amplitude of the UV FFT curve to compensate for a high AGC (Automatic Gain Control) number such as would be the case with a weak flame.

Note: With no flame present, it is normal to see a significant FFT curve amplitude for the UV sensor. Checking “UV AGC” will reduce this amplitude.

IR (InSight scanner only)

Checking “IR” will show the FFT curve for the infrared sensor (if applicable)

IR AGC Check Box (InSight scanner only)

Checking “IR AGC” will reduce the amplitude of the IR FFT curve to compensate for a high AGC (Automatic Gain Control) number such as would be the case with a weak flame.

FQ (InSight scanner only)

The FQ represents the current Flame Quality number (0-100) displayed at the scanner’s keypad / display.



IRAGC (InSight scanner only)

The IRAGC represents the automatic gain control value (0-255) for the infrared sensor (if applicable). With a flame-off condition (or a weak flame-on condition) this number will be high. With a strong flame-on condition, this number will be low.

UVAGC (InSight scanner only)

The UVAGC represents the automatic gain control value (0-255) for the ultraviolet sensor (if applicable). With a flame-off condition (or a weak flame-on condition) this number will be high. With a strong flame-on condition, this number will be low.

TREND GRAPH

The Trend graph shows the scanners flame data over a period of time. Three values can be displayed; the Amplitude, the Slope, and the linear Regression (Signature Scanner only).

SIGNATURE SCANNER TREND

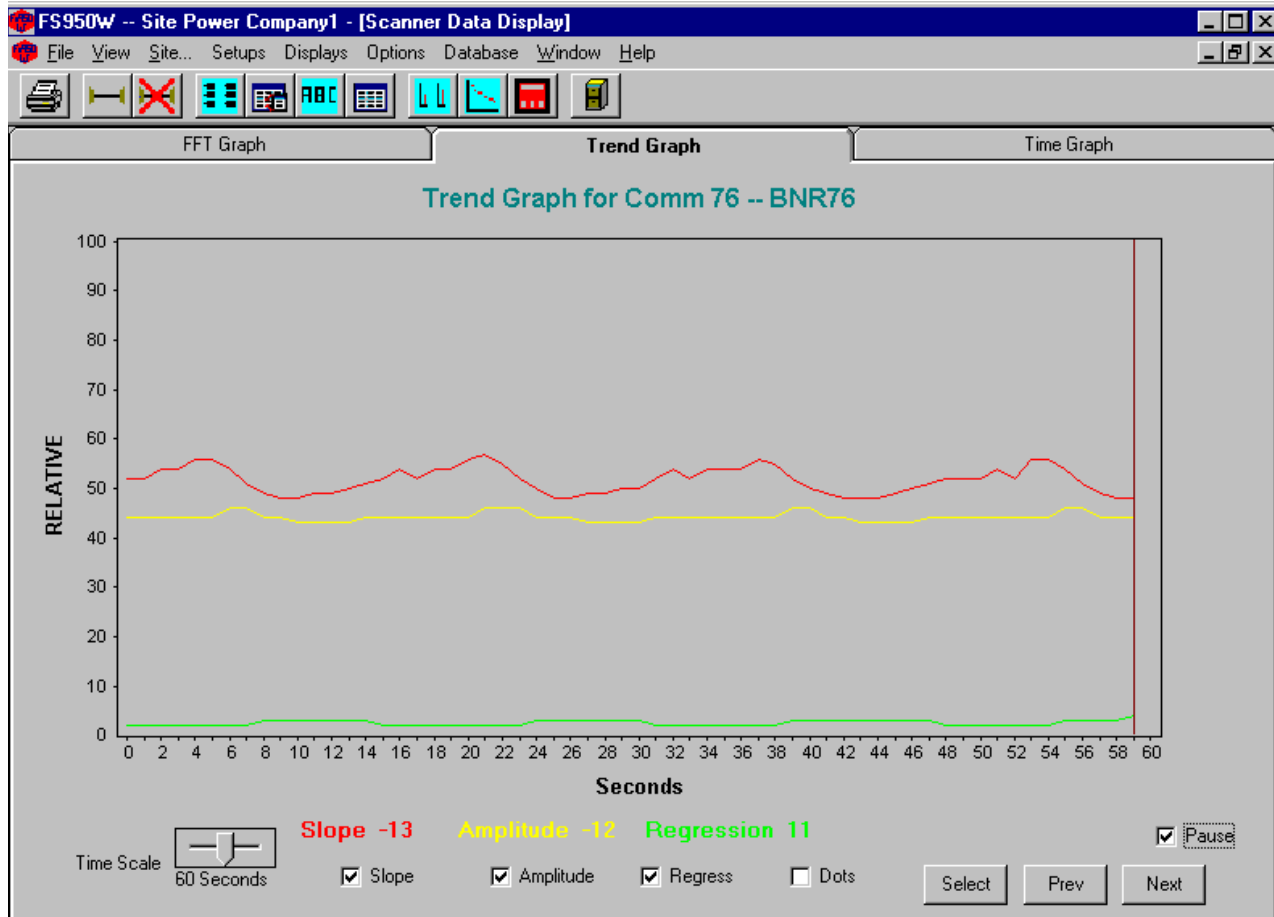

Amplitude (Signature Scanner only)

The Amplitude checkbox toggles on and off the line representing the Flame Amplitude. This is the strength of the flame signal at the frequency that offers the greatest discrimination. The scanner chooses this frequency during the “Learn Flame On” and “Learn Flame Off” procedures. This frequency can be seen in the Scanner Configuration Files beside the title of “Frequency Used for Scanning (XF).”

Slope (Signature Scanner only)

The Slope checkbox toggles on and off the line which represents the difference between the slope lines of the data at a low and high flame flicker frequency e.g. 20 Hz and 80 Hz. When the flame is on the delta slope should be close to zero. With a Flame Off condition the delta slope should increase significantly (e.g. to -40).

Regression (Signature Scanner only)

The Regression checkbox toggles on and off the line representing the Linear Regression. With a “Flame On” condition, the data should be approximately a straight line, so the linear regression should be a low number. With “Flame Off” the linear regression should increase significantly (e.g. 150 – 300).

Dots

The Dots checkbox toggles the displayed values between showing the data as individual dots or lines.

**Time Scale**

The Time Scale slider controller allows the user to select display times of 30 seconds, 60 seconds, or 480 seconds. The graph will continue to scroll when the time period is filled.

Select Button

The Select button allows the user to select a specific scanner without stepping through all those that may be available. The user can either enter the Comm Address or select the unit by description from the available list.

Next and Previous

The "Next" and "Previous" buttons change the scanner being viewed. These buttons will cycle through all the scanners listed in the "Unit Setup."

INSIGHT SCANNER TREND

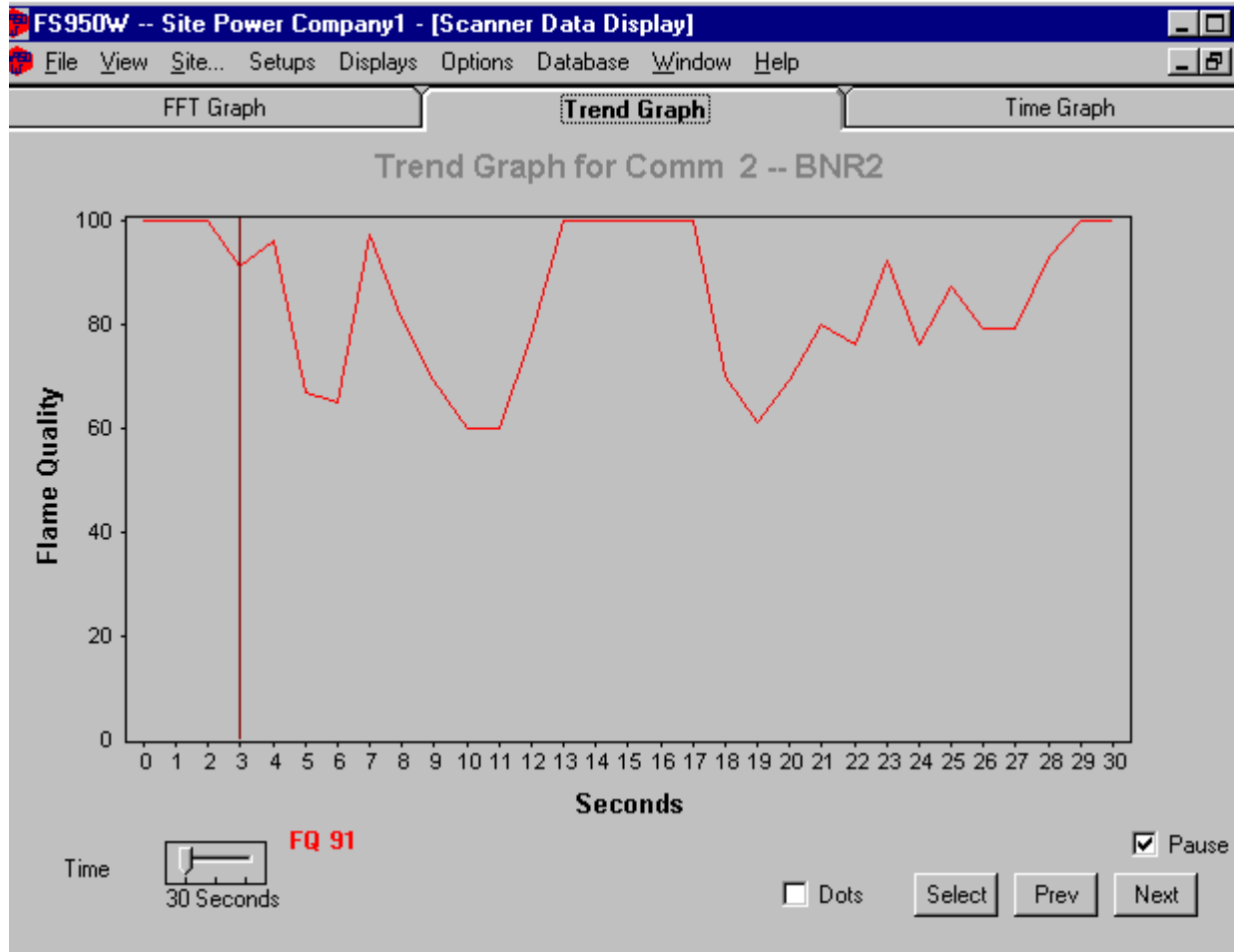

FQ

The TREND screen for an InSight scanner tracks the Flame Quality number (0-100) as shown on the scanner's keypad / display.

TIME GRAPH (Oscilloscope)

The Time Graph display shows the flame signal strength as would be viewed on an oscilloscope. This screen is helpful for checking the flame signal levels. The flame signal levels should be greater than -2.5 VDC and less than $+2.4$ VDC. Flame signal levels outside of this range would indicate an improper GAIN Calibration during the set-up of the scanner.

SIGNATURE SCANNER TIME GRAPH

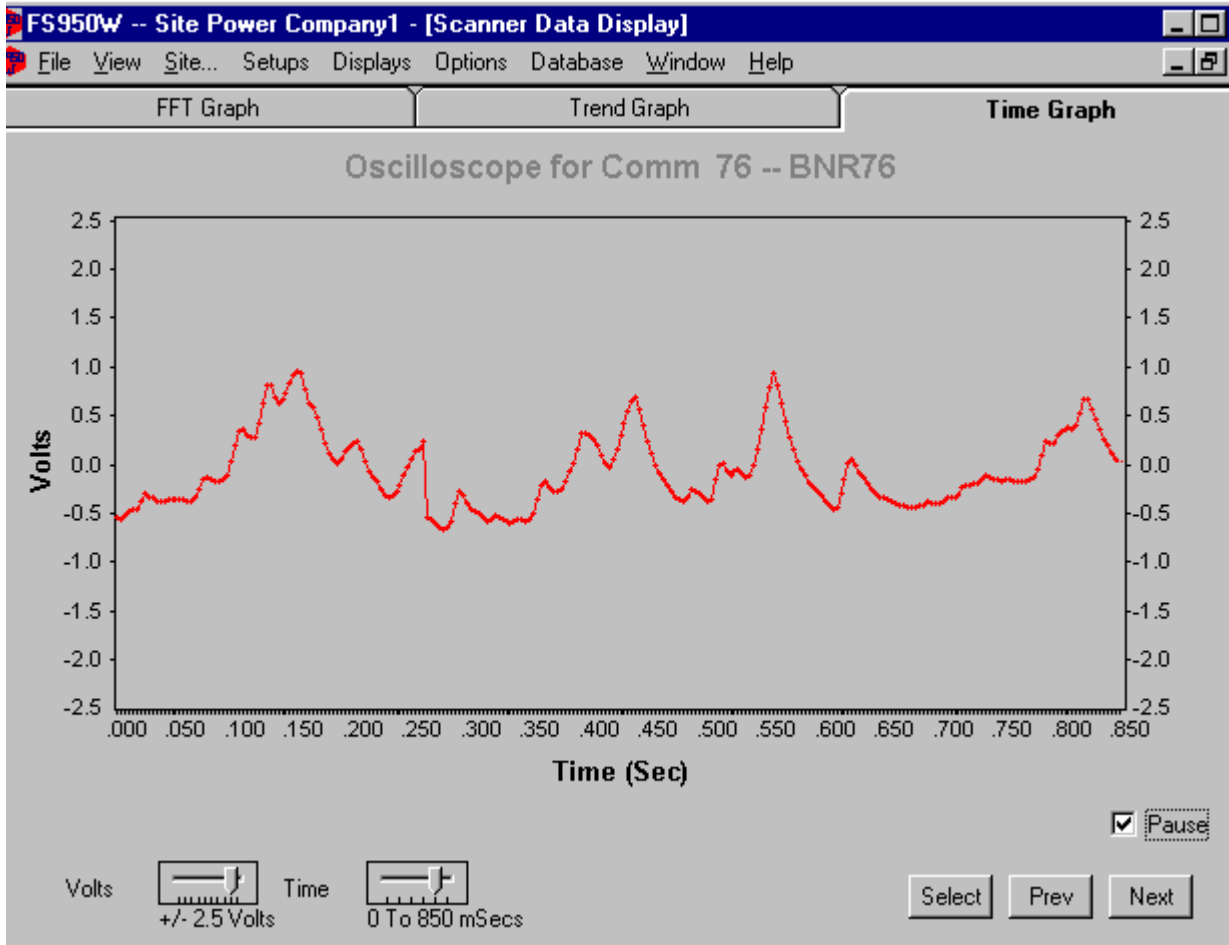

Time Scale

For the Signature Scanner the Time Scale slider controller allows the user to select display times of 50, 110, 210, 430, 850 and 1000 milliseconds. For the InSight scanners the Time Scale slider controller allows the user to select display times of 50, 105, 155, 210, 260 and 312 milliseconds

Volt Scale

The Voltage Scale slider allows the user to select the amplitude of the graph the choices are; $+0.01$, 0.02 , 0.04 , 0.08 , 0.16 , 0.32 , 0.64 , 1.25 , 2.5 and 5.0 Volts. Select Button The Select button allows the user to select a specific scanner without stepping through all those that may be available. The user can either enter the Comm Address or select the unit by description from the available list.

Select Button

The “Select” button allows the user to select a specific scanner without stepping through all the those that may be available. The user can either select the Comm Address or select the unit by description from the available list.

Next and Previous Buttons

The “Next” and “Previous” buttons change the scanner being viewed. These buttons will cycle through all the scanners listed in the “Unit Setup.”

INSIGHT SCANNER TIME GRAPH (DS Model shown)

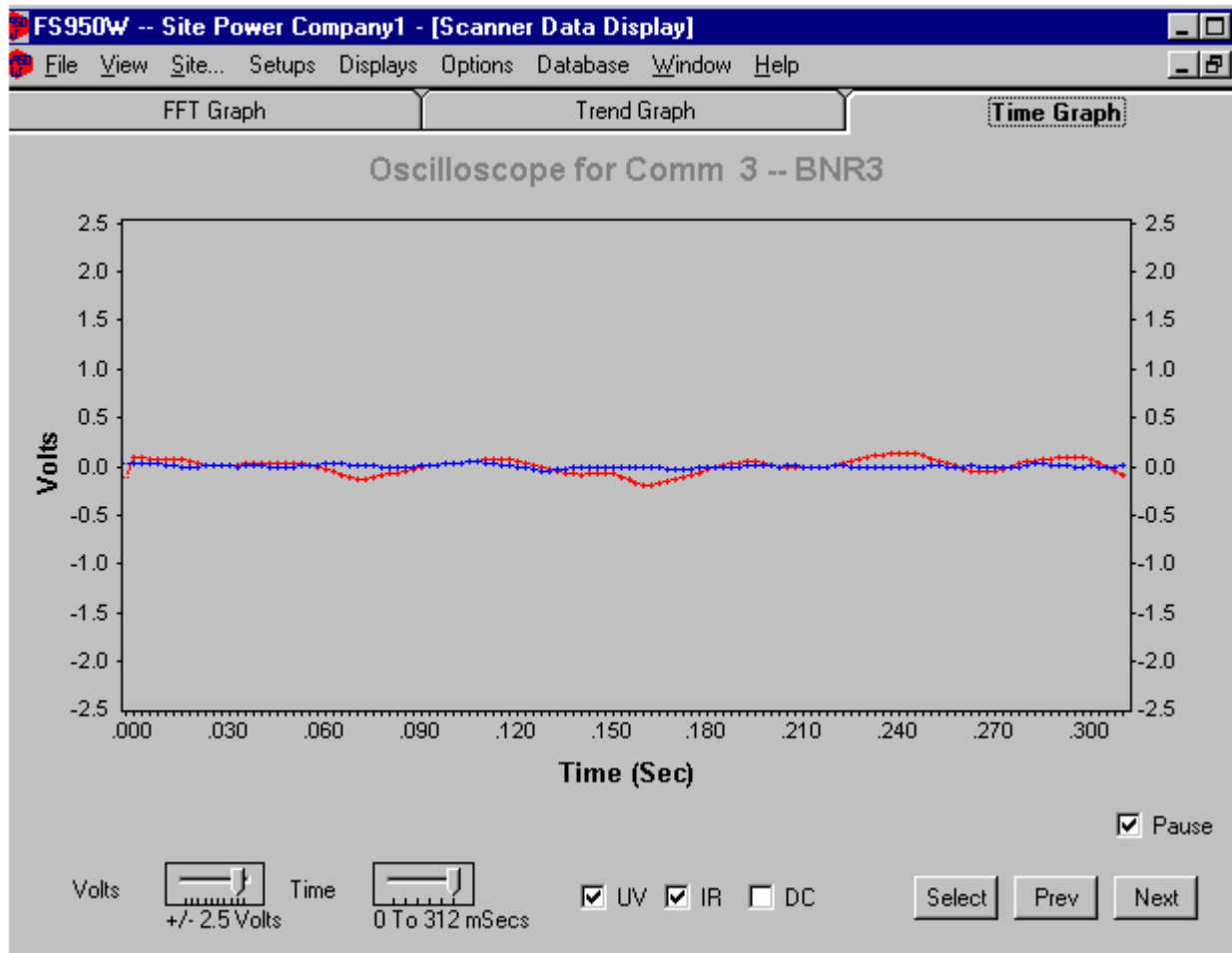

UV (InSight scanner only)

Checking "UV" will show the Time Graph (in blue) for the ultraviolet sensor (if applicable)

IR (InSight scanner only)

Checking "IR" will show the Time Graph (in red) for the infrared sensor (if applicable)

DC (InSight scanner only)

If the graph is off-scale when the volts/division slider is lowered, checking "DC" (DC Coupling) may bring the graph back on-scale. This will vary from scanner to scanner, and with most InSight scanners you will observe no effect.





NOTICE

When Fireeye products are combined with equipment manufactured by others and/or integrated into systems designed or manufactured by others, the Fireeye warranty, as stated in its General Terms and Conditions of Sale, pertains only to the Fireeye products and not to any other equipment or to the combined system or its overall performance.

WARRANTIES

FIREYE guarantees for *one year from the date of installation or 18 months from date of manufacture* of its products to replace, or, at its option, to repair any product or part thereof (except lamps, electronic tubes and photocells) which is found defective in material or workmanship or which otherwise fails to conform to the description of the product on the face of its sales order. **THE FOREGOING IS IN LIEU OF ALL OTHER WARRANTIES AND FIREYE MAKES NO WARRANTY OF MERCHANTABILITY OR ANY OTHER WARRANTY, EXPRESS OR IMPLIED.** Except as specifically stated in these general terms and conditions of sale, remedies with respect to any product or part number manufactured or sold by Fireeye shall be limited exclusively to the right to replacement or repair as above provided. In no event shall Fireeye be liable for consequential or special damages of any nature that may arise in connection with such product or part.



FIREYE®
3 Manchester Road
Derry, New Hampshire 03038 USA
www.fireeye.com

CU-102
APRIL 8, 2013
Supersedes September 14 2005